

**Driver LC 75W 250-400mA 220V o4a Ip ADV**

advanced DALI series

**Product description**

- \_ Dimmable built-in constant current LED driver
- \_ Dimming range 10 – 100 % (min. 25 mA)
- \_ For luminaires of protection class I and protection class II
- \_ Temperature protection as per EN 61347-2-13 C5e
- \_ Adjustable output current between 250 and 400 mA via I-SELECT 2 plugs
- \_ Max. output power 75 W
- \_ Up to 93 % efficiency
- \_ Power input on stand-by < 0.4 W
- \_ Nominal lifetime up to 100,000 h
- \_ 5 years guarantee (conditions at <https://www.tridonic.com/manufacturer-guarantee-conditions>)

**Housing properties**

- \_ Low profile metal casing with white cover
- \_ Type of protection IP20

**Interfaces**

- \_ one4all (DALI-2 DT 6, DSI, switchDIM, corridorFUNCTION V2)
- \_ Terminal blocks: 0° push terminals

**Functions**

- \_ Adjustable output current in 1-mA-steps (I-SELECT 2)
- \_ Protective features (overtemperature, short-circuit, overload, no-load, input voltage range)
- \_ Suitable for emergency escape lighting systems acc. to EN 50172

**Benefits**

- \_ Application-oriented operating window for maximum compatibility

**Typical applications**

- \_ For linear/area lighting

**Website**

<http://www.tridonic.com/87500728>



Spotlights



Downlights



Linear



Area



Floor | Wall



Free-standing



Street



Decorative



High bay

**Driver LC 75W 250-400mA 220V o4a Ip ADV**

advanced DALI series

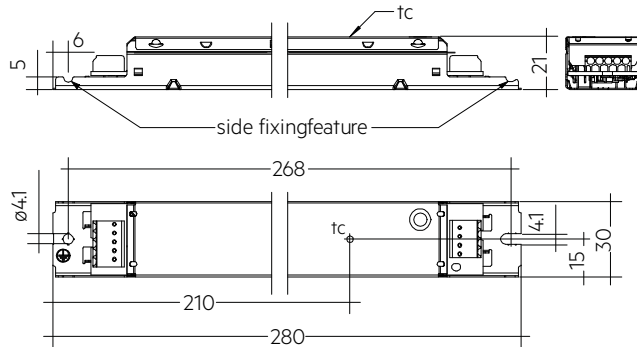
**Ordering data**

Type	Article number	Packaging, carton	Packaging, pallet	Packaging, high volume	Weight per pc.
LC 75/250-400/220 o4a Ip ADV	87500728	40 pc(s).	560 pc(s).	2,240 pc(s).	0.216 kg

**Technical data**

Rated supply voltage	220 – 240 V
AC voltage range	198 – 264 V
DC voltage range	176 – 280 V
Mains frequency	0 / 50 / 60 Hz
Overvoltage protection	320 V AC, 48 h
Typ. current (at 230 V, 50 Hz, full load) <sup>①②</sup>	250 – 365 mA
Typ. current (220 V, 0 Hz, full load, 100 % dimming level) <sup>②</sup>	370 mA
Leakage current (at 230 V, 50 Hz, full load) <sup>①②</sup>	< 350 µA
Max. input power	83 W
Typ. efficiency (at 230 V, 50 Hz, full load) <sup>②</sup>	> 92 %
λ (at 230 V, 50 Hz, full load) <sup>①</sup>	0.95
Typ. power consumption on stand-by <sup>③</sup>	< 0.4 W
Typ. input current in no-load operation	23 mA
Typ. input power in no-load operation	0.65 W
In-rush current (peak / duration)	38.2 A / 289 µs
THD (at 230 V, 50 Hz, full load) <sup>①</sup>	< 10 %
Starting time (at 230 V, 50 Hz, full load) <sup>①</sup>	< 0.6 s
Starting time (DC mode)	< 0.4 s
Switchover time (AC/DC) <sup>④</sup>	< 0.5 s
Turn off time (at 230 V, 50 Hz, full load)	< 0.1 s
Starting time (stand-by)	< 0.5 s
Output current tolerance <sup>⑤⑥</sup>	± 5 %
Max. output current peak (non-repetitive)	≤ output current + 10 %
Output LF current ripple (< 120 Hz)	± 5 %
Max. output voltage (U-OUT)	250 V
Dimming range	10 – 100 % (min. 25 mA)
Mains surge capability (between L - N)	1 kV
Mains surge capability (between L/N - PE)	2 kV
Surge voltage at output side (against PE)	2 kV
Type of protection	IP20
Lifetime	up to 100,000 h
Guarantee (conditions at www.tridonic.com)	5 Year(s)
Dimensions L x W x H	280 x 30 x 21 mm

**Approval marks****Standards**

EN 55015, EN 61000-3-2, EN 61000-3-3, EN 61347-1, EN 61347-2-13, EN 62384, EN 61547, EN 62386-101, EN 62386-102, EN 62386-207 (DALI-2), according to EN 50172, according to EN 60598-2-22

## Specific technical data

Type	Output <sup>①</sup> current	Min. output voltage	Max. output voltage	Max. output power	Typ. power consumption (at 230 V, 50 Hz, full load)	Typ. current consumption (at 230 V, 50 Hz, full load)	tc point max.	Ambient temperature ta	I-SELECT 2 resistor value <sup>⑥</sup>
<b>LC 75/250-400/220 o4a Ip ADV</b>	250 mA	110 V	220.0 V	55.0 W	59.1 W	261 mA	70 °C	-25 ... +50 °C	-
<b>LC 75/250-400/220 o4a Ip ADV</b>	275 mA	110 V	220.0 V	60.5 W	63.8 W	282 mA	70 °C	-25 ... +50 °C	18.18 kΩ
<b>LC 75/250-400/220 o4a Ip ADV</b>	300 mA	110 V	220.0 V	66.0 W	70.3 W	309 mA	70 °C	-25 ... +50 °C	16.67 kΩ
<b>LC 75/250-400/220 o4a Ip ADV</b>	325 mA	110 V	220.0 V	71.5 W	75.7 W	332 mA	70 °C	-25 ... +50 °C	15.38 kΩ
<b>LC 75/250-400/220 o4a Ip ADV</b>	350 mA	110 V	214.3 V	75.0 W	80.3 W	351 mA	70 °C	-25 ... +50 °C	14.29 kΩ
<b>LC 75/250-400/220 o4a Ip ADV</b>	375 mA	110 V	200.0 V	75.0 W	80.4 W	352 mA	75 °C	-25 ... +50 °C	13.33 kΩ
<b>LC 75/250-400/220 o4a Ip ADV</b>	400 mA	110 V	187.5 V	75.0 W	80.5 W	353 mA	75 °C	-25 ... +50 °C	0.00 kΩ

① Valid at 100 % dimming level.

② Depending on the selected output current.

③ Depending on the DALI traffic at the interface.

④ Valid for immediate change of power supply type otherwise the starting time is valid.

⑤ Output current is mean value.

⑥ Not compatible with I-SELECT (generation 1). Calculated resistor value.

## I-SELECT 2 PLUG PRE / EXC

Accessory

**Product description**

- \_ Ready-for-use resistor to set output current value
- \_ Compatible with LED driver featuring I-select 2 interface; not compatible with I-SELECT (generation 1)
- \_ Resistor is base insulated
- \_ Resistor power 0.25 W
- \_ Current tolerance  $\pm 2\%$  additional to output current tolerance
- \_ Compatible with LED driver series PRE and EXC

**Example of calculation**

- \_  $R [k\Omega] = 5 V / I_{out} [mA] \times 1000$
- \_ E96 resistor value used
- \_ Resistor value tolerance  $\leq 1\%$ ; resistor power  $\geq 0.1 W$ ; base insulation necessary
- \_ When using a resistor value beyond the specified range, the output current will automatically be set to the minimum value (resistor value too big), respectively to the maximum value (resistor value too small)

**Website**

<http://www.tridonic.com/28001106>

**Ordering data**

Type	Article number	Colour	Marking	Current	Resistor value	Packaging, bag	Weight per pc.
I-SELECT 2 PLUG 250MA BL	28001106	Blue	0250 mA	250 mA	20.00 k $\Omega$	10 pc(s).	0.001 kg
I-SELECT 2 PLUG 275MA BL	28001107	Blue	0275 mA	275 mA	18.20 k $\Omega$	10 pc(s).	0.001 kg
I-SELECT 2 PLUG 300MA BL	28001108	Blue	0300 mA	300 mA	16.50 k $\Omega$	10 pc(s).	0.001 kg
I-SELECT 2 PLUG 325MA BL	28001109	Blue	0325 mA	325 mA	15.40 k $\Omega$	10 pc(s).	0.001 kg
I-SELECT 2 PLUG 350MA BL	28001110	Blue	0350 mA	350 mA	14.30 k $\Omega$	10 pc(s).	0.001 kg
I-SELECT 2 PLUG 375MA BL	28001111	Blue	0375 mA	375 mA	13.30 k $\Omega$	10 pc(s).	0.001 kg
I-SELECT 2 PLUG 400MA BL	28001112	Blue	0400 mA	400 mA	12.40 k $\Omega$	10 pc(s).	0.001 kg
I-SELECT 2 PLUG MAX BL	28001099	Blue	MAX	MAX	0.00 k $\Omega$	10 pc(s).	0.001 kg

## 1. Standards

EN 55015  
 EN 61000-3-2  
 EN 61000-3-3  
 EN 61347-1  
 EN 61347-2-13  
 EN 62384  
 EN 61547  
 EN 62386-101 (DALI-2)  
 EN 62386-102 (DALI-2)  
 EN 62386-207 (DALI-2)

According to EN 50172 for use in central battery systems

According to EN 60598-2-22 suitable for emergency lighting installations

## 2. Thermal details and lifetime

### 2.1 Expected lifetime

Expected lifetime				
Type	Output current	ta	40 °C	50 °C
LC 75/250-400/220 o4a lp ADV	250 – 350 mA	tc	60 °C	70 °C
		Lifetime	> 100,000 h	> 100,000 h
	>350 – 400 mA	tc	65 °C	75 °C
		Lifetime	> 100,000 h	50,000 h

The LED Driver is designed for a lifetime stated above under reference conditions and with a failure probability of less than 10 %.

The relation of tc to ta temperature depends also on the luminaire design.

If the measured tc temperature is approx. 5 K below tc max., ta temperature should be checked and eventually critical components (e.g. ELCAP) measured. Detailed information on request.

## 3. Installation / wiring

### 3.1 Circuit diagram

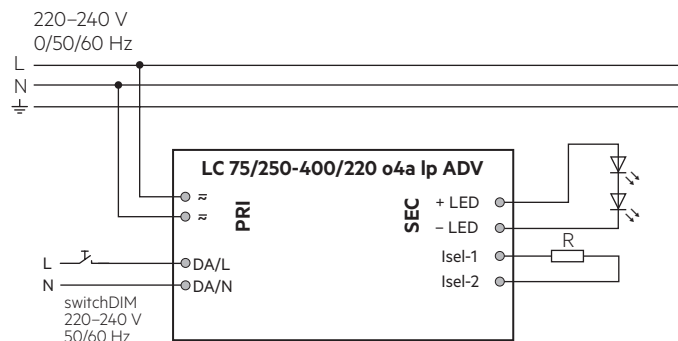
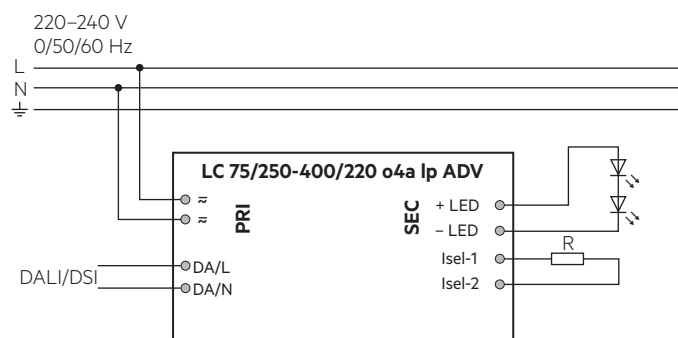

### 3.2 Wiring type and cross section

Solid wire with a cross section of 0.5 – 1.5 mm<sup>2</sup>. Strip 8 – 9 mm of insulation from the cables to ensure perfect operation of terminals.

LED module/LED Driver/supply

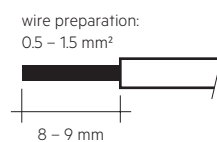

### 3.3 Loose wiring

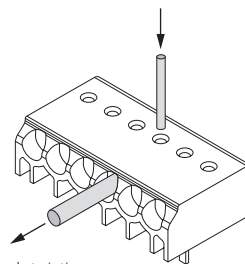

Loosen wire through twisting and pulling or using a Ø 1 mm release tool

### 3.4 Wiring guidelines

- The cables should be run separately from the mains connections and mains cables to ensure good EMC conditions.
- The LED wiring should be kept as short as possible to ensure good EMC. The max. secondary cable length is 2 m (4 m circuit), this applies for LED output as well as for I-SELECT 2.
- Secondary switching is not permitted.
- The LED Driver has no inverse-polarity protection on the secondary side. Wrong polarity can damage LED modules with no inverse-polarity protection.
- Wrong wiring of the LED Driver can lead to malfunction or irreparable damage.
- To avoid the damage of the Driver, the wiring must be protected against short circuits to earth (sharp edged metal parts, metal cable clips, louver, etc.).

### 3.5 Hot plug-in

Hot plug-in is not supported due to residual output voltage of > 0 V. If a LED load is connected the device has to be restarted before the output will be activated again. This can be done via mains reset or via interface (DALI, DSI, switchDIM).

### 3.6 Earth connection

The earth connection is conducted as protection earth (PE). The LED Driver can be earthed via metal housing. If the LED Driver will be earthed, protection earth (PE) has to be used. There is no earth connection required for the functionality of the LED Driver. Earth connection is recommended to improve following behaviour:

- Electromagnetic interferences (EMI)
- LED glowing at stand-by
- Transmission of mains transients to the LED output

In general it is recommended to earth the LED Driver if the LED module is mounted on earthed luminaire parts respectively heat sinks and thereby representing a high capacity against earth. To avoid the LED modules from glowing in standby, consider the capacitance against earth for larger area LED modules.

### 3.7 I-SELECT 2 resistors connected via cable

For details see:  
[http://www.tridonic.com/com/en/download/technical/LCA\\_PRE\\_LC\\_EXC\\_ProductManual\\_en.pdf](http://www.tridonic.com/com/en/download/technical/LCA_PRE_LC_EXC_ProductManual_en.pdf).

## 4. Electrical values

### 4.1 Operating window

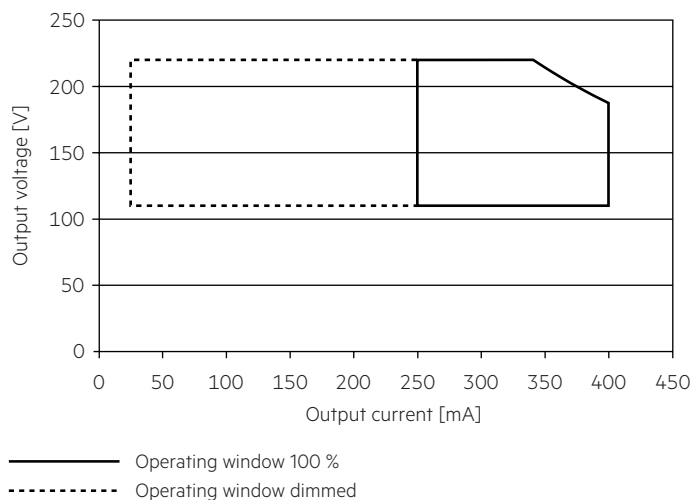

Make sure that the LED Driver is operated within the given window under all operating conditions. Special attention needs to be paid at dimming and DC emergency operation as the forward voltage of the connected LED modules varies with the dimming level, due to the implemented amplitude dimming technology. Coming below the specified minimum output voltage of the LED Driver may cause the device to shut-down. See chapter "6.7 Light level in DC operation" for more information.

### 4.2 Efficiency vs load

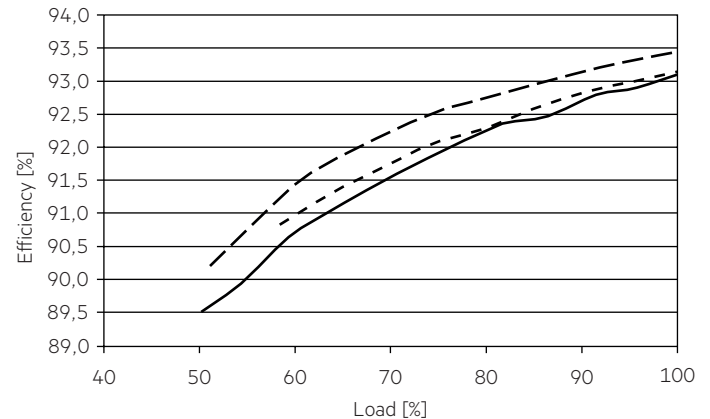

### 4.3 Power factor vs load

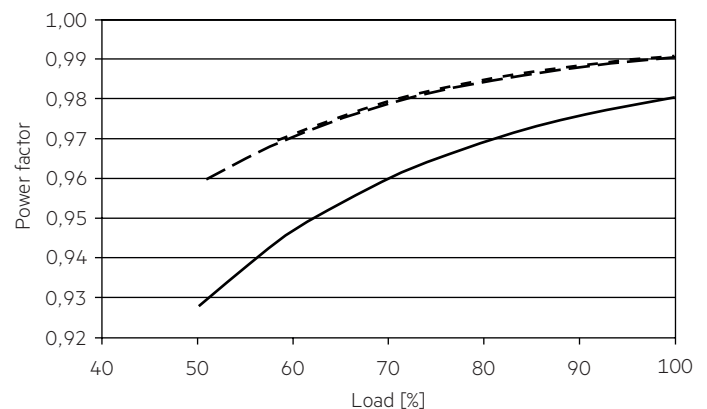

### 4.4 THD vs load

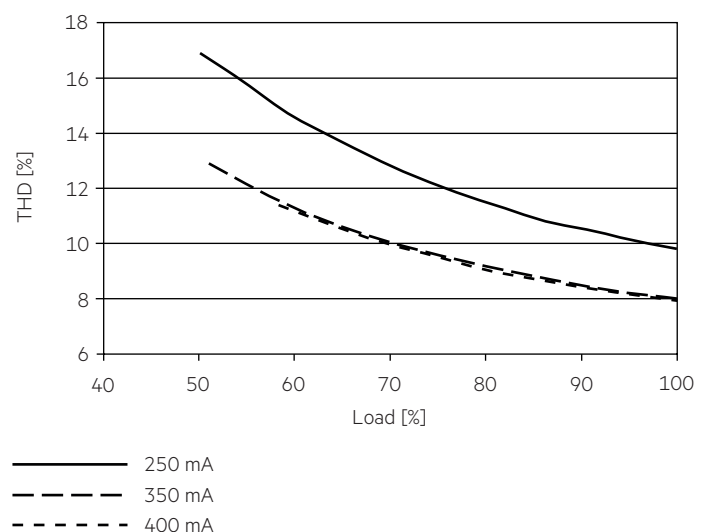

100 % load corresponds to the max. output power (full load) according to the table on page 2.

#### 4.5 Maximum loading of automatic circuit breakers in relation to inrush current

Automatic circuit breaker type	C10	C13	C16	C20	B10	B13	B16	B20	Inrush current	
	Installation Ø	1.5 mm <sup>2</sup>	1.5 mm <sup>2</sup>	2.5 mm <sup>2</sup>	2.5 mm <sup>2</sup>	1.5 mm <sup>2</sup>	1.5 mm <sup>2</sup>	2.5 mm <sup>2</sup>	2.5 mm <sup>2</sup>	I <sub>max</sub>
<b>LC 75/250-400/220 o4a Ip ADV</b>	10	13	16	21	6	8	10	13	38.2 A	289 µs

This are max. values calculated out of inrush current! Please consider not to exceed the maximum rated continuous current of the circuit breaker.

Calculation uses typical values from ABB series S200 as a reference.

Actual values may differ due to used circuit breaker types and installation environment.

#### 4.6 Harmonic distortion in the mains supply (at 230 V / 50 Hz and full load) in %

	THD	3.	5.	7.	9.	11.
<b>LC 75/250-400/220 o4a Ip ADV</b>	< 10	< 7	< 7	< 5	< 3	< 3

#### 4.7 Dimming

Dimming range 10 % to 100 %

Digital control with:

- DSI signal: 8 bit Manchester Code  
Speed 10 % to 100 % in 1.4 s
- DALI signal: 16 bit Manchester Code  
Speed 10 % to 100 % in 0.2 s  
Programmable parameter:  
Minimum dimming level  
Maximum dimming level  
Default minimum = 10 %  
Programmable range 10 % ≤ MIN ≤ 100 %  
Default maximum = 100 %  
Programmable range 100 % ≥ MAX ≥ 10 %

Dimming curve is adapted to the eye sensitiveness.

Dimming is realized by amplitude dimming.

#### 4.8 Dimming characteristics

Digital dimming value

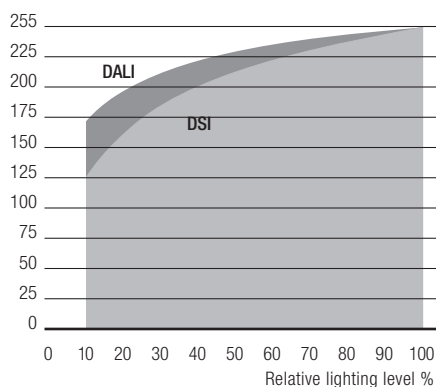

Dimming characteristics as seen by the human eye

## 5. Interfaces / communication

### 5.1 Control input (DA/N, DA/L)

Digital DALI signal or switchDIM can be wired on the same terminals (DA/N and DA/L).

The control input is non-polar for digital control signals (DALI, DSI). The control signal is not SELV. Control cable has to be installed in accordance to the requirements of low voltage installations.

Different functions depending on each module.

### 5.2 switchDIM

Integrated switchDIM function allows a direct connection of a pushbutton for dimming and switching.

Brief push (< 0.6 s) switches LED Driver ON and OFF. The dimm level is saved at power-down and restored at power-up.

When the pushbutton is held, LED modules are dimmed. After repush the LED modules are dimmed in the opposite direction.

In installations with LED Drivers with different dimming levels or opposite dimming directions (e.g. after a system extension), all LED Drivers can be synchronized to 50 % dimming level by a 10 s push.

Use of pushbutton with indicator lamp is not permitted.

## 6. Functions

### 6.1 Function: adjustable current

The output current of the LED Driver can be adjusted in a certain range.

By inserting a suitable resistor into the I-SELECT 2 interface, the current value can be adjusted. The relationship between output current and resistor value can be found in the chapter "Accessories I-SELECT 2 Plugs".



Please note that the resistor values for I-SELECT 2 are not compatible with I-SELECT (generation 1). Installation of an incorrect resistor may cause irreparable damage to the LED module(s).

Resistors for the main output current values can be ordered from Tridonic (see accessories).

## 6.2 Short-circuit behaviour

In case of a short-circuit at the LED output the LED output is switched off. After restart of the LED Driver the output will be activated again. The restart can either be done via mains reset or via interface (DALI, DSI, switchDIM).

## 6.3 No-load operation

The LED Driver will not be damaged in no-load operation. The output will be deactivated and is therefore free of voltage. If a LED load is connected the device has to be restarted before the output will be activated again.

## 6.4 Overload protection

If the maximum load is exceeded by a defined internal limit, the LED Driver turns off the LED output. After restart of the LED Driver the output will be activated again. The restart can either be done via mains reset or via interface (DALI, DSI, switchDIM).

## 6.5 Overtemperature protection

If the temperature limit is exceeded, the LED Driver is shutdown and the temperature protection is activated approx. 20 °C above  $t_c$  max. If the temperature drops back to the allowed temperature range the LED Driver restarts automatically.

## 6.6 corridorFUNCTION

The corridorFUNCTION can be programmed in two different ways. To program the corridorFUNCTION by means of software a DALI-USB interface is needed in combination with a DALI PS. The software can be the masterCONFIGURATOR.

To activate the corridorFUNCTION without using software a voltage of 230 V has to be applied for five minutes at the switchDIM connection. The unit will then switch automatically to the corridorFUNCTION.

Note:

If the corridorFUNCTION is wrongly activated in a switchDIM system (for example a switch is used instead of pushbutton), there is the option of installing a pushbutton and deactivating the corridorFUNCTION mode by five short pushes of the button within three seconds.

switchDIM and corridorFUNCTION are very simple tools for controlling gears with conventional pushbuttons or motion sensors.

To ensure correct operation a sinusoidal mains voltage with a frequency of 50 Hz or 60 Hz is required at the control input.

Special attention must be paid to achieving clear zero crossings. Serious mains faults may impair the operation of switchDIM and corridorFUNCTION.

## 6.7 Light level in DC operation

The LED Driver is designed to operate on DC voltage and pulsed DC voltage. For a reliable operation, make sure that also in DC emergency operation the LED Driver is run within the specified conditions as stated in chapter "4.1 operating window".

Light output level in DC operation (EOF<sub>i</sub>): 95 % (cannot be adjusted)

The voltage-dependent input current of Driver incl. LED module is depending on the used load.

The voltage-dependent no-load current of Driver (without or defect LED module) is for:

AC: <25 mA (at 230 V, 50 Hz)

DC: 1 – 3 mA (at 280 – 176 V, 0 Hz)

## 6.8 Software / programming

With appropriate software and an interface different functions can be activated and various parameters can be configured in the LED Driver. To do so, a DALI-USB and the software (masterCONFIGURATOR) are required.

## 6.9 masterCONFIGURATOR

For further information see masterCONFIGURATOR manual.

## 6.10 deviceCONFIGURATOR

PC (windows) based software application to transfer parameters into our drivers.

Workflow optimised for the use in OEM production line.

For further information see deviceCONFIGURATOR manual.

## 7. Miscellaneous

### 7.1 Insulation and electric strength testing of luminaires

Electronic devices can be damaged by high voltage. This has to be considered during the routine testing of the luminaires in production.

According to IEC 60598-1 Annex Q (informative only!) or ENEC 303-Annex A, each luminaire should be submitted to an insulation test with 500 V<sub>DC</sub> for 1 second. This test voltage should be connected between the interconnected phase and neutral terminals and the earth terminal. The insulation resistance must be at least 2 MΩ.

As an alternative, IEC 60598-1 Annex Q describes a test of the electrical strength with 1500 V<sub>AC</sub> (or 1.414 x 1500 V<sub>DC</sub>). To avoid damage to the electronic devices this test must not be conducted.

### 7.2 Conditions of use and storage

Humidity: 5% up to max. 85 %,  
not condensed  
(max. 56 days/year at 85 %)

Storage temperature: -40 °C up to max. +80 °C

The devices have to be acclimatised to the specified temperature range (ta) before they can be operated.

The LED Driver is declared as inbuilt LED controlgear, meaning it is intended to be used within a luminaire enclosure.

If the product is used outside a luminaire, the installation must provide suitable protection for people and environment (e.g. in illuminated ceilings).

### 7.3 Maximum number of switching cycles

All LED Driver are tested with 50,000 switching cycles.

### 7.4 Additional information

Additional technical information at [www.tridonic.com](http://www.tridonic.com) → Technical Data

Lifetime declarations are informative and represent no warranty claim.  
No warranty if device was opened.