

**Driver LCBI 10W 180/350/500mA PHASE-CUT/1-10V Ip**  
advanced series

**Product description**

- \_ Dimmable built-in constant current LED driver
- \_ Constant current LED driver
- \_ Dimmable via leading edge and trailing edge phase dimmers
- \_ Dimmable via 1... 10 V
- \_ Output dimmed analogue (current amplitude)
- \_ Dimming range typ. 10 to 100 % (depending on dimmer)
- \_ For luminaires of protection class I and protection class II
- \_ Temperature protection as per EN 61347-2-13 C5e
- \_ SELV
- \_ Output current 180, 350 or 500 mA
- \_ Output power 10 W
- \_ Nominal lifetime up to 50,000 h
- \_ 5 years guarantee (conditions at <https://www.tridonic.com/manufacture-guarantee-conditions>)

**Housing properties**

- \_ Casing: polycarbonate, white
- \_ Type of protection IP20
- \_ Push-in terminals

**Functions**

- \_ Overload protection
- \_ Short-circuit protection
- \_ No-load protection
- \_ No output current overshoot at mains on/off

**Website**

<http://www.tridonic.com/87500282>



Spotlights



Downlights



Linear



Area



Floor | Wall



Free-standing



Street



Decorative



High bay

### Driver LCBI 10W 180/350/500mA PHASE-CUT/1-10V Ip advanced series

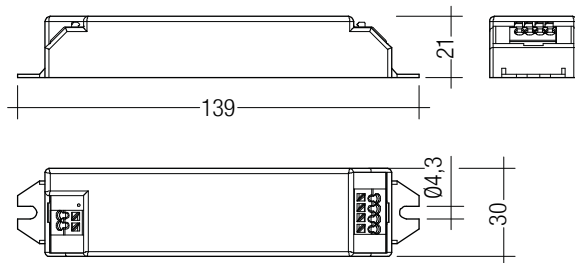

#### Ordering data

Type	Article number	Packaging, carton	Packaging, pallet	Packaging, high volume	Weight per pc.
LCBI 10W 180mA PHASE-CUT/1-10V LP	87500282	30 pc(s).	960 pc(s).	6,720 pc(s).	0.064 kg
LCBI 10W 350mA PHASE-CUT/1-10V LP	87500283	30 pc(s).	960 pc(s).	6,720 pc(s).	0.062 kg
LCBI 10W 500mA PHASE-CUT/1-10V LP	87500284	30 pc(s).	960 pc(s).	6,720 pc(s).	0.064 kg

#### Technical data

Rated supply voltage	220 – 240 V
AC voltage range	198 – 264 V
Typ. rated current (at 230 V, 50 Hz, full load)	58 mA
$\lambda$ at full load	0.95
$\lambda$ over full operating range (min.)	0.9C
Mains frequency	50 Hz
Overvoltage protection	300 V AC, 1 h
Max. input power	13 W
Output power	5 – 10 W
THD (at 230 V, 50 Hz, full load)	< 20 %
THD (at 230 V, 50 Hz, min. load)	< 20 %
Control input <sup>①</sup>	1...10 V, potentiometer 200 k $\Omega$
Output current tolerance (at 230 V, 50 Hz, full load) <sup>②</sup>	$\pm$ 7.5 %
Output current tolerance (at 230 V, 50 Hz, min. load) <sup>②</sup>	$\pm$ 10 %
Typ. current ripple (at 230 V, 50 Hz, full load)	$\pm$ 40 %
Starting time (at 230 V, 50 Hz, full load)	$\leq$ 0.5 s
Turn off time (at 230 V, 50 Hz, full load)	$\leq$ 0.2 s
Hold on time at power failure (output)	0 s
Ambient temperature $t_a$	-20 ... +50 °C
Ambient temperature $t_a$ (at lifetime 50,000 h)	50 °C
Max. casing temperature $t_c$	65 °C
Storage temperature $t_s$	-40 ... +85 °C
Lifetime	up to 50,000 h
Guarantee (conditions at <a href="http://www.tridonic.com">www.tridonic.com</a> )	5 Year(s)
Dimensions L x W x H	139 x 30 x 21 mm

#### Approval marks



#### Standards

EN 55015, EN 60598-1, EN 61000-3-2, EN 61000-3-3, EN 61347-1, EN 61347-2-13, EN 61547, EN 62384

## Specific technical data

Type	Output current <sup>②</sup>	Efficiency at full load <sup>③</sup>	Efficiency at min. load <sup>③</sup>	Min. forward voltage <sup>③</sup>	Max. forward voltage <sup>③</sup>	Max. output voltage (U-OUT)	Max. repetitive output peak current at full load	Max. repetitive output peak current at min. load	Max. non-repetitive output peak current at full load	Max. non-repetitive output peak current at min. load
<b>LCBI 10W 180mA PHASE-CUT/1-10V LP</b>	180 mA	79 %	78 %	28 V	56 V	65 V	260 mA	310 mA	260 mA	310 mA
<b>LCBI 10W 350mA PHASE-CUT/1-10V LP</b>	350 mA	78 %	75 %	14 V	28 V	45 V	500 mA	570 mA	500 mA	570 mA
<b>LCBI 10W 500mA PHASE-CUT/1-10V LP</b>	500 mA	77 %	73 %	10 V	20 V	35 V	740 mA	870 mA	740 mA	870 mA

① 1 ... 10 V DC source with double or reinforced insulation with respect to AC mains. Max. source current: 0.1 mA. Suitable for passiv and active control.

② Output current is mean value.

③ Test result at 230 V, 50 Hz without dimmer connected.

**Standards**

EN 55015  
 EN 61000-3-2  
 EN 61000-3-3  
 EN 61347-1  
 EN 61347-2-13  
 EN 61547  
 EN 62384

**Overload protection**

If the maximum load is exceeded by a defined internal limit, the LED driver reduces the LED output current. After elimination of the overload the nominal operation is restored automatically.

**Short-circuit behaviour**

In case of a short circuit on the secondary side (LED) the LED driver switches off. After elimination of the short circuit the nominal operation is restored automatically.

**No-load operation**

The LED driver works in burst working mode to provide a constant output voltage regulation which allows the application to be able to work safely when LED string open due a failure.

In no-load operation the output voltage will not exceed the specified max. out-put voltage (see page 2).

**Dimming**

Dimming range 10 % to 100 %

Control with:

- Potentiometer
- 1 ... 10 V
- Both phase cut and 1 ... 10 V dimmer connect together in one device is not permitted and may cause flicker.
- In 1 ... 10 V dimming applications, the system SELV depends on the dimmer. If a SELV 1 ... 10 V dimmer is used, the system will be SELV.
- Wrong polarity input to the 1 – 10 V interface will damage the LED driver.

**1 ... 10 V function**

The light intensity of the LEDs vary proportionally to the signal sent to the terminal.

**Potentiometer function**

By rotating the potentiometer there is variation of the LED light intensity in a proportionate or logarithmic way depending on the model of potentiometer used. The use of a logarithmic potentiometer is recommended.

Humidity: 5 % up to max. 85 %,  
 not condensed  
 (max. 56 days/year at 85 %)

Storage temperature: -40 °C up to max. +85 °C

The devices have to be within the specified temperature range (ta) before they can be operated.

**Glow wire test**

according to EN 60598-1 with increased temperature of 850 °C passed.

**Expected lifetime**

Type	ta	40 °C	50 °C	60 °C
<b>LCBI 10W xxxmA PHASE-CUT/1-10 V LP</b>	tc	55 °C	65 °C	x
	Lifetime	50,000 h	30,000 h	x

The LED drivers are designed for a lifetime stated above under reference conditions and with a failure probability of less than 10 %.

The relation of tc to ta temperature depends also on the luminaire design. If the measured tc temperature is approx. 5 K below tc max., ta temperature should be checked and eventually critical components (e.g. ELCAP) measured. Detailed information on request.

**Maximum loading of automatic circuit breakers in relation to inrush current**

Automatic circuit breaker type	C10				C13				C16				C20				B10				B13				B16				B20				Inrush current	
	Installation Ø		1.5 mm <sup>2</sup>		1.5 mm <sup>2</sup>		1.5 mm <sup>2</sup>		2.5 mm <sup>2</sup>		1.5 mm <sup>2</sup>		1.5 mm <sup>2</sup>		1.5 mm <sup>2</sup>		2.5 mm <sup>2</sup>		1.5 mm <sup>2</sup>		1.5 mm <sup>2</sup>		1.5 mm <sup>2</sup>		2.5 mm <sup>2</sup>		I <sub>max</sub>	Time						
<b>LCBI 10W 180mA PHASE-CUT/1-10 V LP</b>	60		90		120		140		30		45		60		70		10 A		100 µs															
<b>LCBI 10W 350mA PHASE-CUT/1-10 V LP</b>	60		90		120		140		30		45		60		70		10 A		100 µs															
<b>LCBI 10W 500mA PHASE-CUT/1-10 V LP</b>	60		90		120		140		30		45		60		70		10 A		100 µs															

These are max. values calculated out of inrush current! Please consider not to exceed the maximum rated continuous current of the circuit breaker. Calculation uses typical values from ABB series S200 as a reference.

Actual values may differ due to used circuit breaker types and installation environment.

**Harmonic distortion in the mains supply (at 230 V / 50 Hz and full load) in %**

	THD	3.	5.	7.	9.	11.
<b>LCBI 10W 180mA PHASE-CUT/1-10 V LP</b>	20	9	10	7	5	3
<b>LCBI 10W 350mA PHASE-CUT/1-10 V LP</b>	20	10	10	7	5	3
<b>LCBI 10W 500mA PHASE-CUT/1-10 V LP</b>	20	11	10	7	5	3

**Installation instructions**

The LED module and all contact points within the wiring must be sufficiently insulated against 2.8 kV surge voltage.  
Air and creepage distance must be maintained.

**Replace LED module**

1. Mains off
2. Remove LED module
3. Wait for 20 seconds
4. Connect LED module again

Hot plug-in or secondary switching of LEDs is not permitted and may cause a very high current to the LEDs.

**Wiring type and cross section**

For wiring use stranded wire with ferrules or solid wire from 0.5 – 1.5 mm<sup>2</sup>. Strip 8.5 – 9.5 mm of insulation from the cables to ensure perfect operation of the push-wire terminals (WAGO 250).

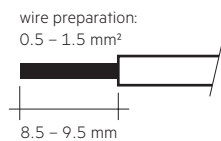
**Release of the wiring**

Press down the “push button” and remove the cable from front.

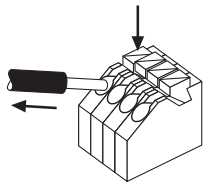
**Mounting of device**

Max. torque for fixing: 0.5 Nm/M4

**Wiring guidelines**

- All connections must be kept as short as possible to ensure good EMI behaviour.
- Mains leads should be kept apart from LED driver and other leads (ideally 5 – 10 cm distance)
- Max. length of output wires is 2 m.
- Secondary switching is not permitted.
- Incorrect wiring can damage LED modules.
- To avoid the damage of the Driver, the wiring must be protected against short circuits to earth (sharp edged metal parts, metal cable clips, louver, etc.).

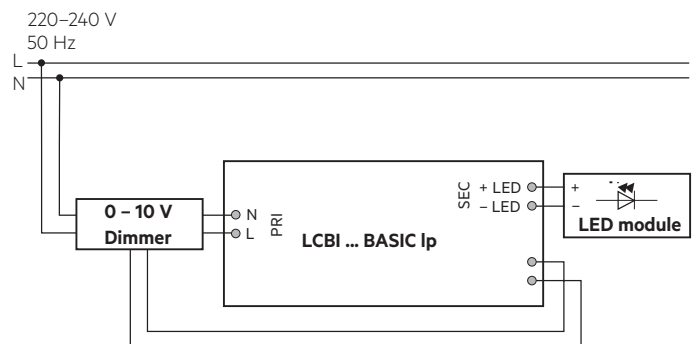
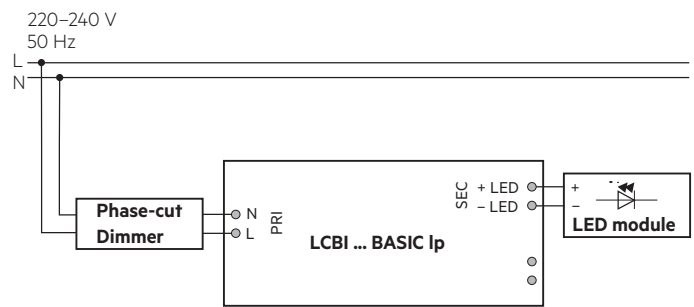
**Wiring diagram****Insulation and electric strength testing of luminaires**

Electronic devices can be damaged by high voltage. This has to be considered during the routine testing of the luminaires in production.

According to IEC 60598-1 Annex Q (informative only!) or ENEC 303-Annex A, each luminaire should be submitted to an insulation test with 500 V<sub>DC</sub> for 1 second. This test voltage should be connected between the interconnected phase and neutral terminals and the earth terminal.

The insulation resistance must be at least 2 MΩ.

As an alternative, IEC 60598-1 Annex Q describes a test of the electrical strength with 1500 V<sub>AC</sub> (or 1.414 x 1500 V<sub>DC</sub>). To avoid damage to the electronic devices this test must not be conducted.

**Conditions of use**

The LED driver is declared as inbuilt LED controlgear, meaning it is intended to be used within a luminaire enclosure.

If the product is used outside a luminaire, the installation must provide suitable protection for people and environment (e.g. in illuminated ceilings).

**Maximum number of switching cycles**

All LED driver are tested with 50,000 switching cycles.

**Additional information**

Additional technical information at [www.tridonic.com](http://www.tridonic.com) → Technical Data

Lifetime declarations are informative and represent no warranty claim.  
No warranty if device was opened.

Diagrams LCBI 10W 180mA PHASE-CUT/1-10 V LP

Efficiency vs load

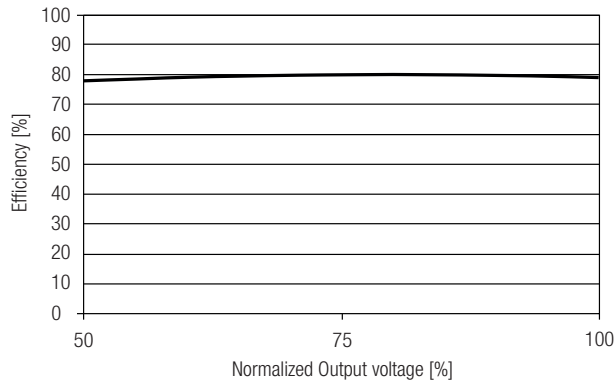

Power factor vs load

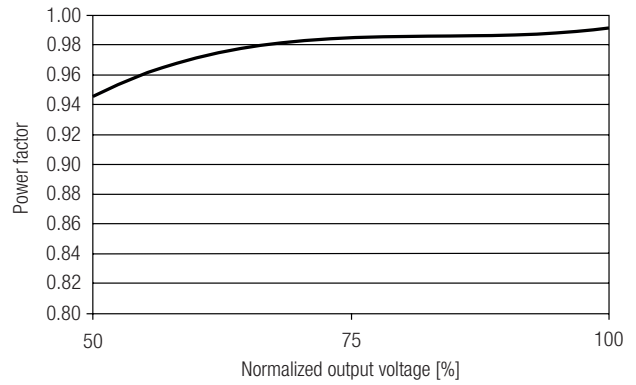

THD vs load

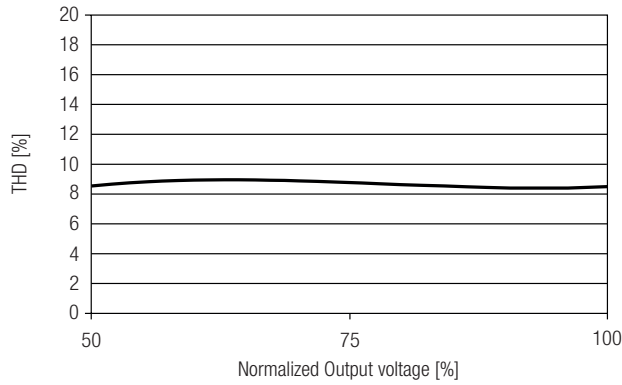

Input current vs load

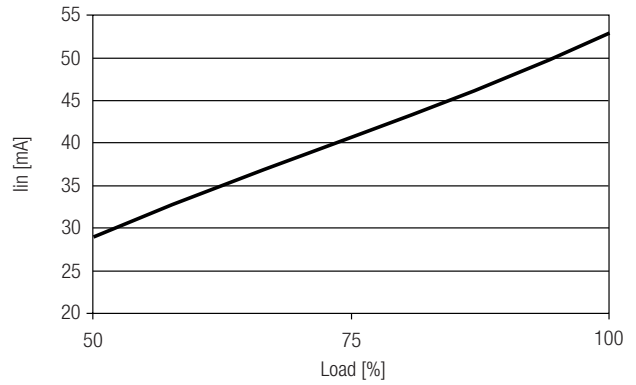

Input power vs load

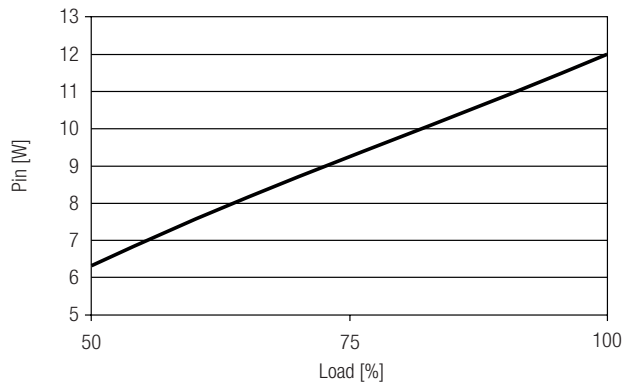

Output current vs dimming resistance

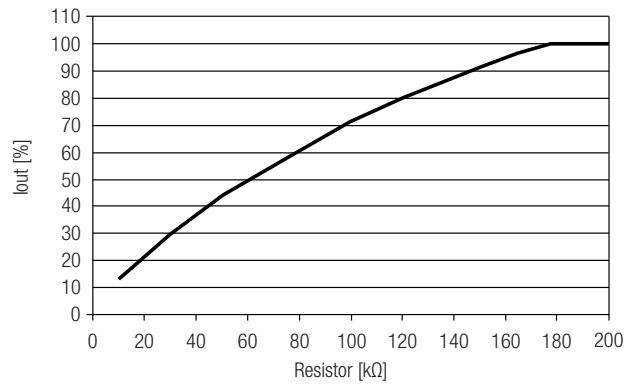

Phase cut dimming curve (depends dimmer)  
Output current vs dimming angle

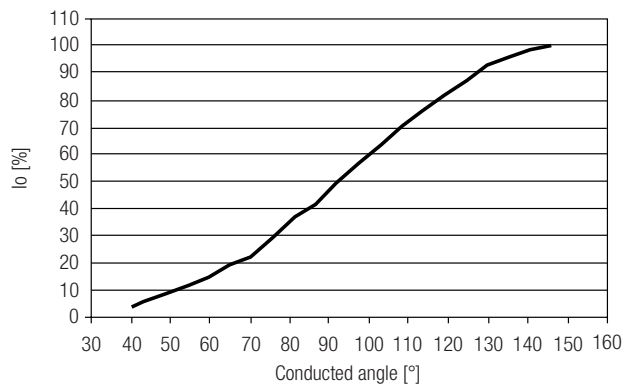

1 - 10 V dimming curve  
Output current vs dimming voltage

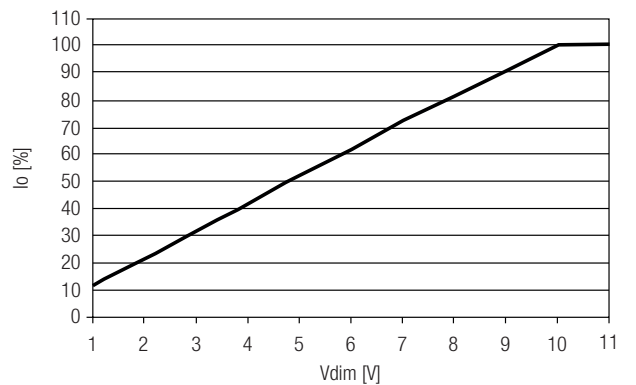

Diagrams LCBI 10W 350mA PHASE-CUT/1-10 V LP

Efficiency vs load

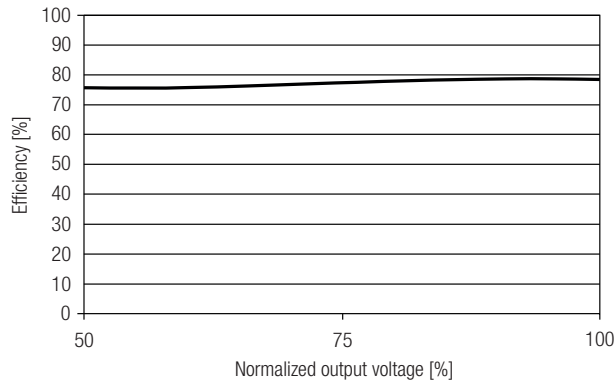

Power factor vs load

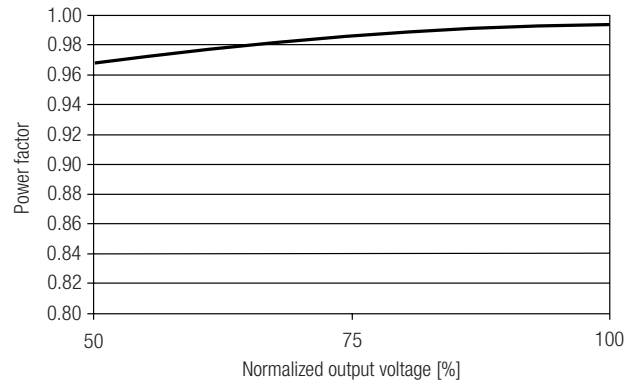

THD vs load

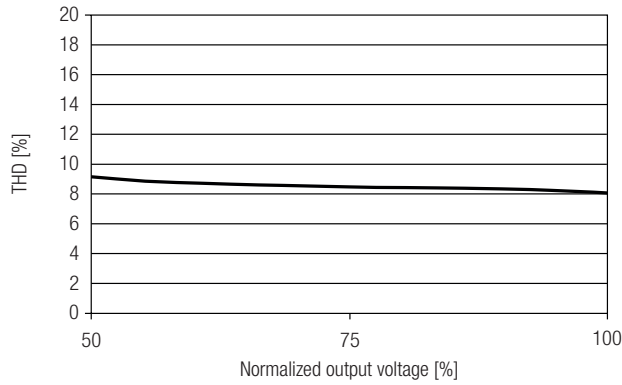

Input current vs load

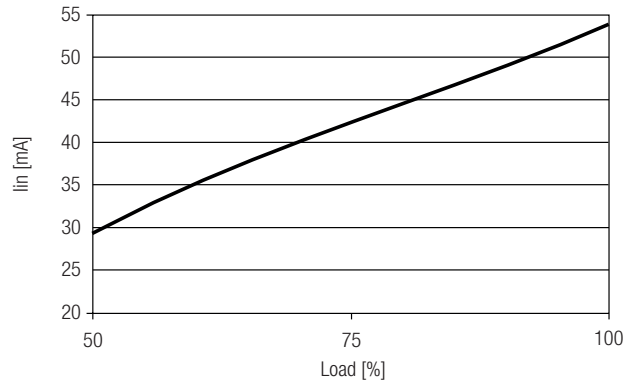

Input power vs load

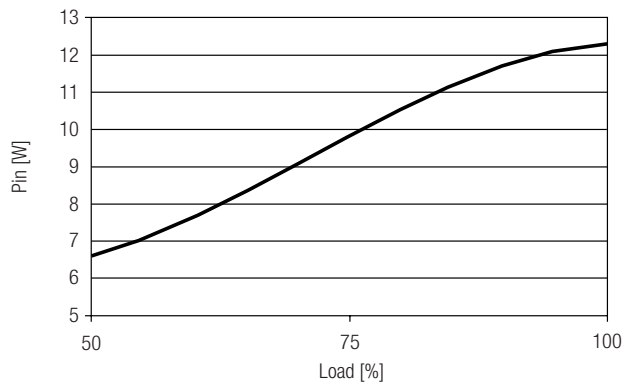

Output current vs dimming resistance

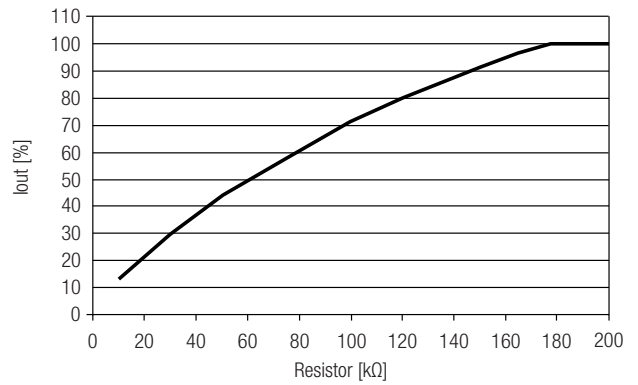

Phase cut dimming curve (depends dimmer)  
Output current vs dimming angle

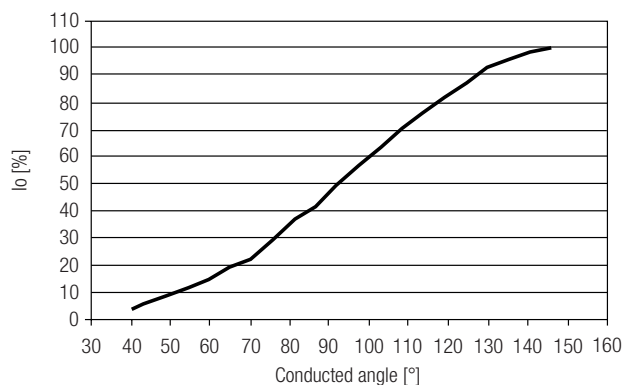

1 - 10 V dimming curve  
Output current vs dimming voltage

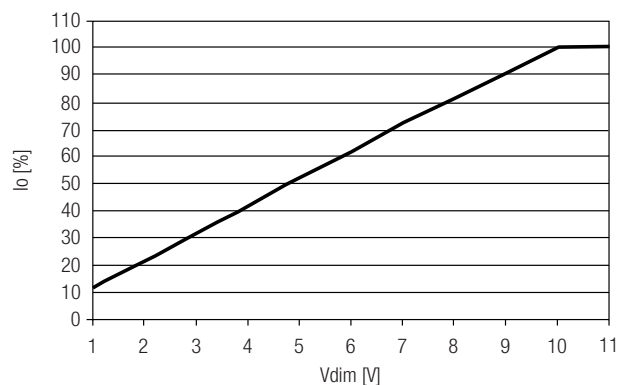

Diagrams LCBI 10W 500mA PHASE-CUT/1-10 V LP

Efficiency vs load

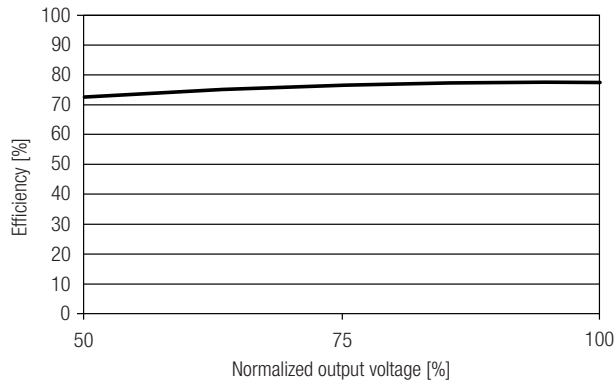

Power factor vs load

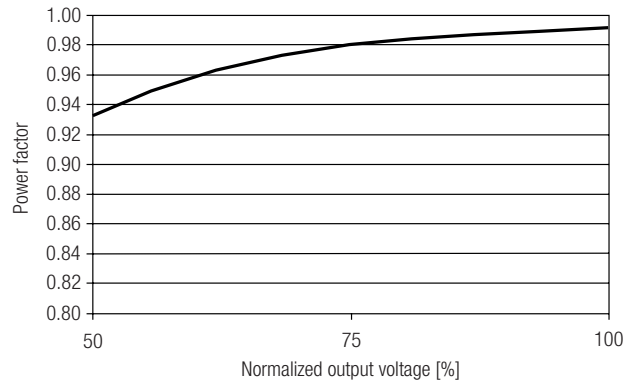

THD vs load

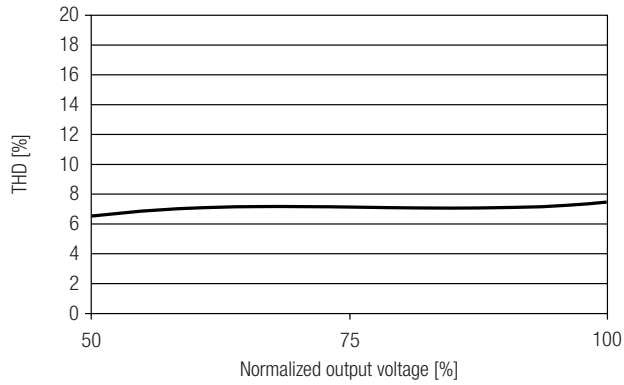

Input current vs load

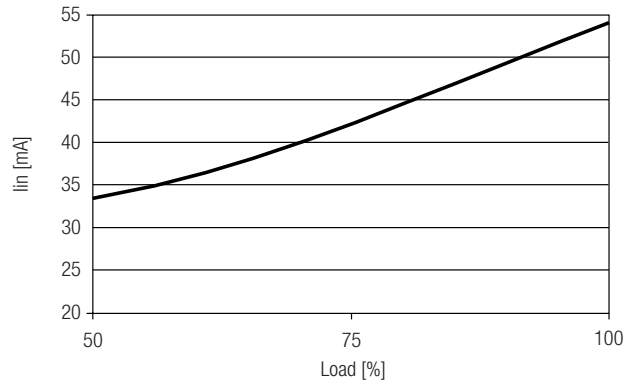

Input power vs load

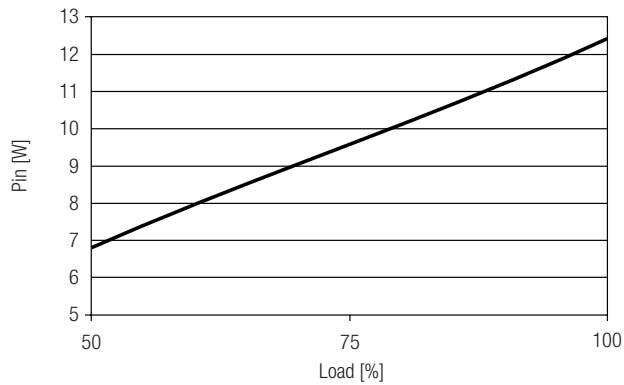

Output current vs dimming resistance

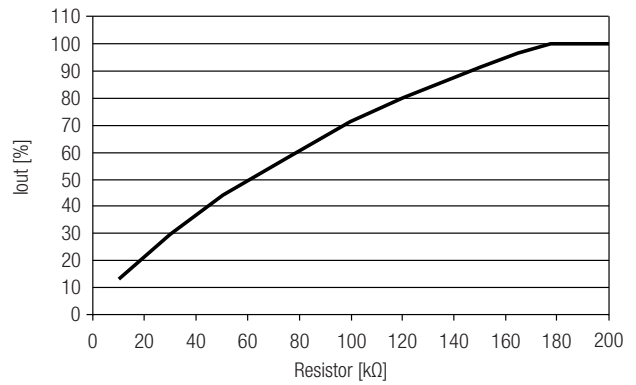

Phase cut dimming curve (depends dimmer)  
Output current vs dimming angle

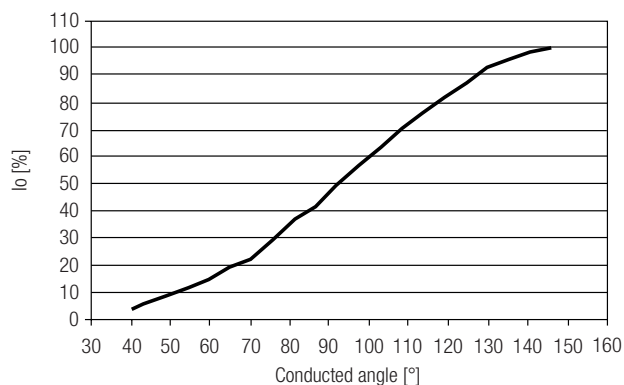

1 - 10 V dimming curve  
Output current vs dimming voltage

