

Driver LC 200W 24V IP67 L EXC UNV

excite series 24 V – not dimmable (IP67)

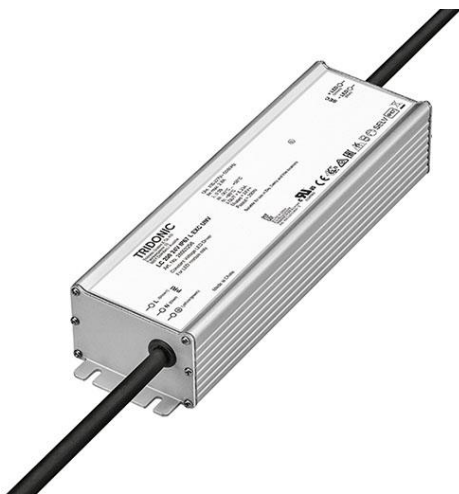

Product description

- _ Constant voltage LED driver
- _ Universal input voltage range
- _ Max. output power 200 W
- _ Nominal lifetime up to 50,000 h
- _ 5 years guarantee (conditions at <https://www.tridonic.com/manufacturer-guarantee-conditions>)

Housing properties

- _ Casing: aluminium, grey
- _ Type of protection IP67
- _ Dry, damp and wet location
- _ Potted version: higher protection against corrosion

Functions

- _ Overtemperature protection
- _ Overload protection
- _ Short-circuit protection
- _ No-load protection

Website

<http://www.tridonic.com/28003298>

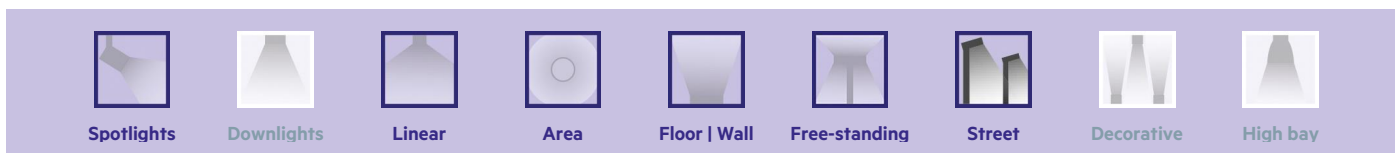

Driver LC 200W 24V IP67 L EXC UNV

excite series 24 V – not dimmable (IP67)

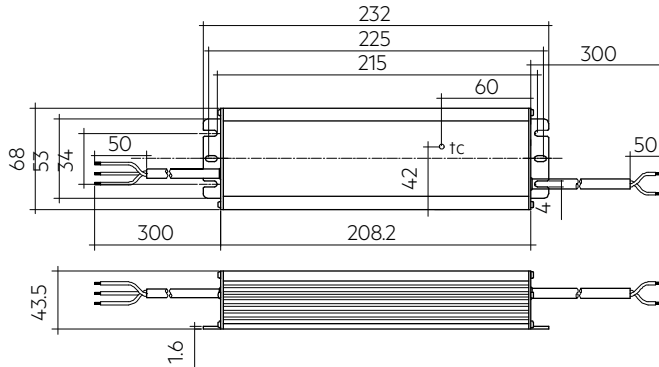
**Ordering data**

Type	Article number	Packaging, carton	Packaging, pallet	Weight per pc.
LC 200 24V IP67 L EXC UNV	28003298	10 pc(s).	200 pc(s).	1.4 kg

Technical data

Rated supply voltage	100 – 277 V
AC voltage range	90 – 305 V
Mains frequency	50 / 60 Hz
Rated current (at 120 V, 60 Hz, full load)	2.8 A
Rated current (at 230 V, 50 Hz, full load)	2.8 A
Rated current (at 277 V, 60 Hz, full load)	2.8 A
Leakage current (at 120 V, 60 Hz, full load)	< 750 μ A
Leakage current (at 230 V, 50 Hz, full load)	< 750 μ A
Leakage current (at 277 V, 60 Hz, full load)	< 750 μ A
Efficiency (at 120 V 60 Hz, full load)	> 88 %
Efficiency (at 230 V, 50 Hz, full load)	> 90 %
Efficiency (at 277 V 60 Hz, full load)	> 90 %
λ (at 120 V, 60 Hz, full load)	0.98
λ (at 230 V, 50 Hz, full load)	0.95
λ (at 277 V, 60 Hz, full load)	0.9C
Typ. input power in no-load operation	1.56 W
Output voltage tolerance	22.8 – 25.2 V
Max. output power	200 W
Output LF voltage ripple (< 120 Hz)	\pm 5 %
Starting time (output)	\leq 1 s
Hold on time at power failure (output)	\leq 1 ms
Mains burst capability	1 kV
Mains surge capability (between L - N)	5 kV
Mains surge capability (between L/N - PE)	10 kV
Surge voltage at output side (against PE)	< 0.5 kV
Max. casing temperature tc	85 °C
Ambient temperature ta (at lifetime 50,000 h)	40 °C
Storage temperature ts	-40 ... +85 °C
Type of protection	IP67
Lifetime	up to 50,000 h
Guarantee (conditions at www.tridonic.com)	5 Year(s)
Dimensions L x W x H	232 x 68 x 43.5 mm
Hole spacing D	215 mm

Approval marks**Standards**

EN 55015, EN 61000-3-2, EN 61000-3-3, EN 61347-1, EN 61347-2-13, EN 62384, EN 60598-1, UL 8750

Specific technical data

Type	Load	Output voltage	Output current	Max. output power (at full load)	Typ. power consumption (at 120 V, 60 Hz, full load)	Typ. current consumption (at 120 V, 60 Hz, full load)	Typ. power consumption (at 230 V, 50 Hz, full load)	Typ. current consumption (at 230 V, 50 Hz, full load)	Typ. power consumption (at 277 V, 60 Hz, full load)	Typ. current consumption (at 277 V, 60 Hz, full load)	Ambient temperature t_a
LC 200 24V IP67 L EXC UNV	10 %	24.1 V	832 mA	20.0 W	25.5 W	241 mA	25.2 W	175 mA	25.0 W	211 mA	-40 ... +50 °C
LC 200 24V IP67 L EXC UNV	20 %	24.1 V	1,666 mA	40.3 W	47.0 W	405 mA	47.2 W	305 mA	46.6 W	233 mA	-40 ... +50 °C
LC 200 24V IP67 L EXC UNV	30 %	24.1 V	2,499 mA	60.4 W	68.9 W	583 mA	68.5 W	424 mA	68.3 W	352 mA	-40 ... +50 °C
LC 200 24V IP67 L EXC UNV	40 %	24.0 V	3,330 mA	80.5 W	90.1 W	761 mA	89.1 W	502 mA	89.2 W	487 mA	-40 ... +50 °C
LC 200 24V IP67 L EXC UNV	50 %	24.0 V	4,165 mA	100.6 W	111.8 W	944 mA	110.1 W	590 mA	109.7 W	537 mA	-40 ... +50 °C
LC 200 24V IP67 L EXC UNV	60 %	24.0 V	4,998 mA	120.7 W	133.2 W	1,121 mA	131.2 W	659 mA	130.7 W	628 mA	-40 ... +50 °C
LC 200 24V IP67 L EXC UNV	70 %	23.9 V	5,831 mA	140.7 W	155.3 W	1,309 mA	152.1 W	720 mA	151.4 W	703 mA	-40 ... +50 °C
LC 200 24V IP67 L EXC UNV	80 %	23.9 V	6,664 mA	160.8 W	176.7 W	1,483 mA	172.8 W	779 mA	171.9 W	768 mA	-40 ... +50 °C
LC 200 24V IP67 L EXC UNV	90 %	23.9 V	7,497 mA	180.7 W	198.9 W	1,672 mA	194.3 W	867 mA	193.1 W	828 mA	-40 ... +50 °C
LC 200 24V IP67 L EXC UNV	100 %	23.9 V	8,330 mA	200.6 W	221.3 W	1,864 mA	216.5 W	958 mA	214.1 W	875 mA	-40 ... +50 °C

1. Standards

EN 55015
 EN 61000-3-2
 EN 61000-3-3
 EN 61347-1
 EN 61347-2-13
 EN 62384
 EN 60598-1
 UL8750

2. Thermal details and lifetime

2.1 Expected lifetime

120 V, 60 Hz

Type	Output voltage	ta	45 °C	50 °C	55 °C	60 °C
LC 200W 24V IP67 L EXC UNV	24 V	tc	80 °C	85 °C	90 °C	95 °C
		Lifetime	> 20,000 h	> 15,000 h	> 10,000 h	> 5,000 h

230 V, 50 Hz

Type	Output voltage	ta	55 °C	60 °C	65 °C	70 °C
LC 200W 24V IP67 L EXC UNV	24 V	tc	80 °C	85 °C	90 °C	95 °C
		Lifetime	> 35,000 h	> 20,000 h	> 15,000 h	> 10,000 h

277 V, 60 Hz

Type	Output voltage	ta	55 °C	60 °C	65 °C	70 °C
LC 200W 24V IP67 L EXC UNV	24 V	tc	75 °C	80 °C	85 °C	90 °C
		Lifetime	> 50,000 h	> 35,000 h	> 25,000 h	> 15,000 h

3. Installation / Wiring

3.1 Wiring diagram

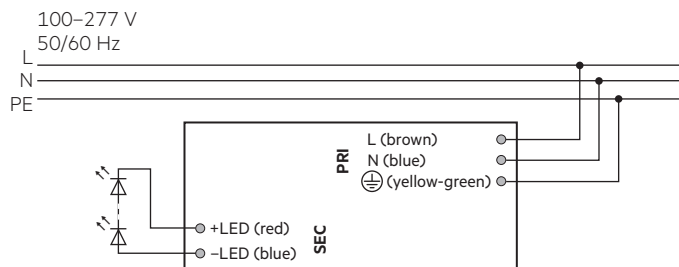

3.2 Connection

Primary cable			Secondary cable	
L	N	PE	+	-
brown	blue	yellow-green	brown	blue

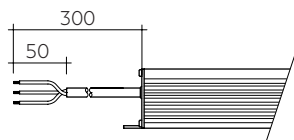

PRI:
3x1.0 mm²

SEC:
2x1.0 mm²

3.3 Wiring guidelines

- All connections must be kept as short as possible to ensure good EMI behaviour.
- To comply with the EMC regulations run the secondary wires (LED module) in parallel.
- Mains leads should be kept apart from LED driver and other leads (ideally 5 – 10 cm distance)
- Max. length of output wires is 2 m.
- Secondary switching is not permitted.
- Incorrect wiring can damage LED modules.
- To avoid the damage of the Driver, the wiring must be protected against short circuits to earth (sharp edged metal parts, metal cable clips, louver, etc.).

3.4 Hot plug-in

Hot plug-in is supported.

3.5 Earth connection

The earth connection is conducted as protection earth (PE). The LED driver can be earthed via metal housing. If the LED driver will be earthed, protection earth (PE) has to be used. There is no earth connection required for the functionality of the LED driver. Earth connection is recommended to improve following behaviour:

- Electromagnetic interferences (EMI)
- LED glowing at standby
- Transmission of mains transients to the LED output

In general it is recommended to earth the LED driver if the LED module is mounted on earthed luminaire parts respectively heat sinks and thereby representing a high capacity against earth.

3.6 Installation instructions

The functioning of the LC in combination with dimming devices (e.g. PWM) cannot be guaranteed and has to be checked individually before using in combination.

For fulfilling the ecodesign requirements of the European Union following has to be considered:

- Going to stand-by via PWM dimmer is not supported.
- To turn off the luminaire, mains has to be off.

4. Electrical values

4.1.1 Efficiency vs. load 120 V, 60 Hz

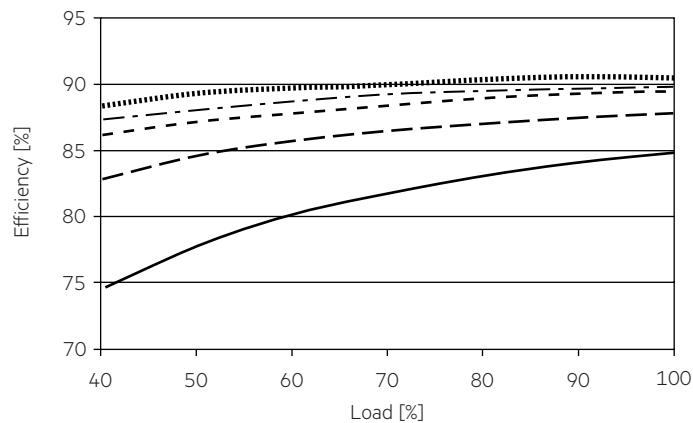

4.1.2 Efficiency vs. load 230 V, 50 Hz

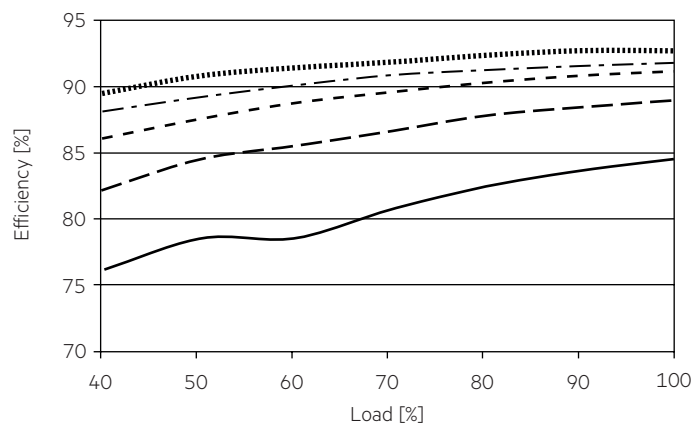

4.1.3 Efficiency vs. load 277 V, 60 Hz

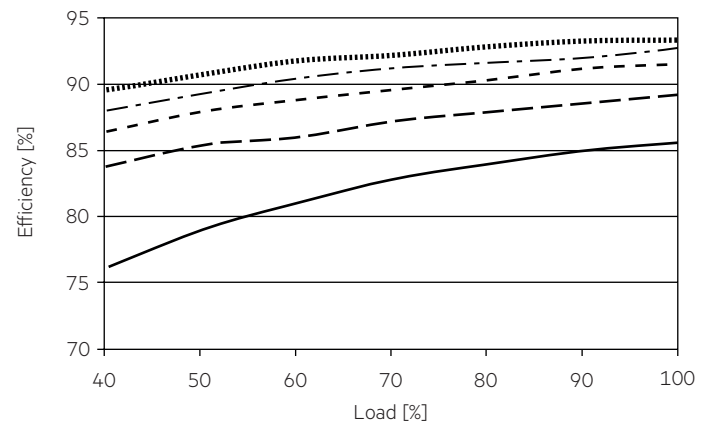

4.2.1 Power factor vs. load 120 V, 60 Hz

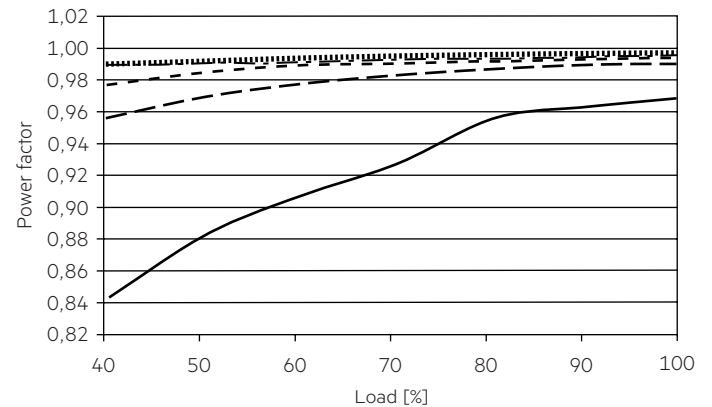

4.2.2 Power factor vs. load 230 V, 50 Hz

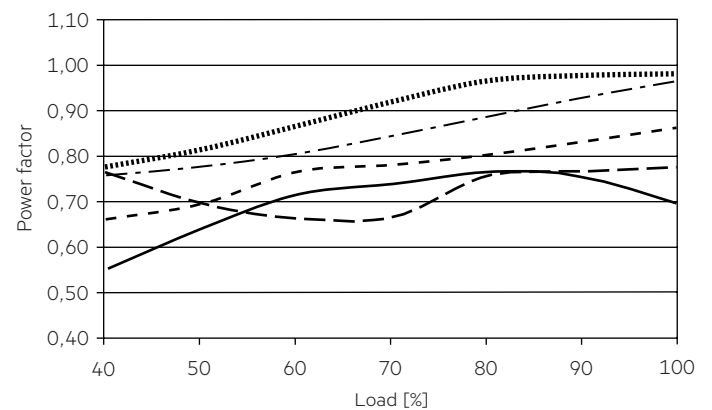

4.2.3 Power factor vs. load 277 V, 60 Hz

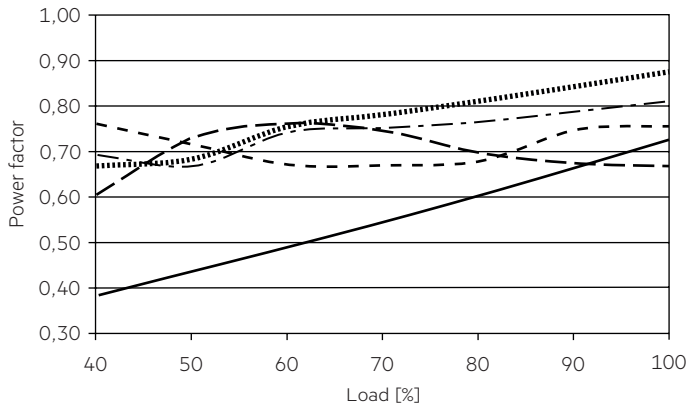

4.3.3 THD vs. load 277 V, 60 Hz

THD without harmonic < 5 mA or 0.6 % of the input current.

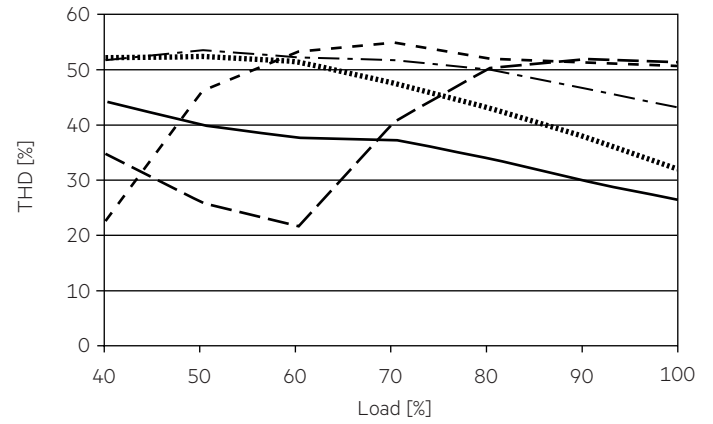

4.3.1 THD vs. load 120 V, 60 Hz

THD without harmonic < 5 mA or 0.6 % of the input current.

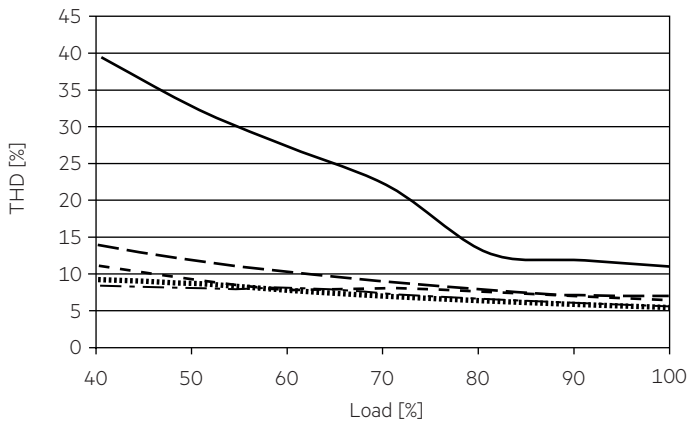

4.4.1 Input current vs. load 120 V, 60 Hz

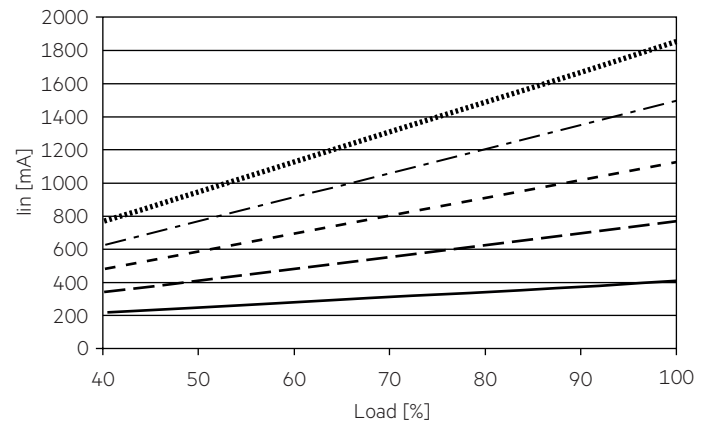

4.3.2 THD vs. load 230 V, 50 Hz

THD without harmonic < 5 mA or 0.6 % of the input current.

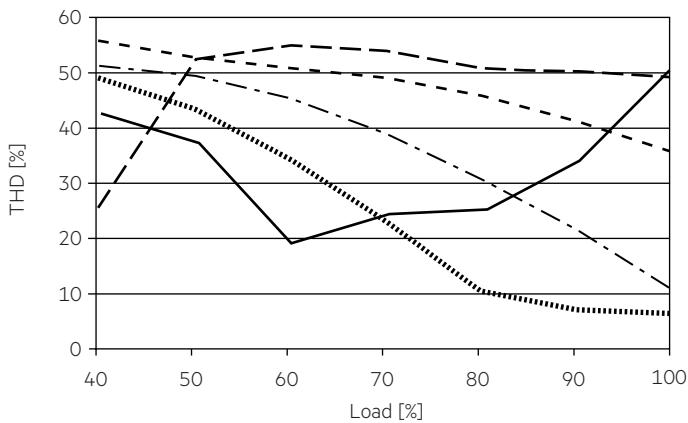

4.4.2 Input current vs. load 230 V, 50 Hz

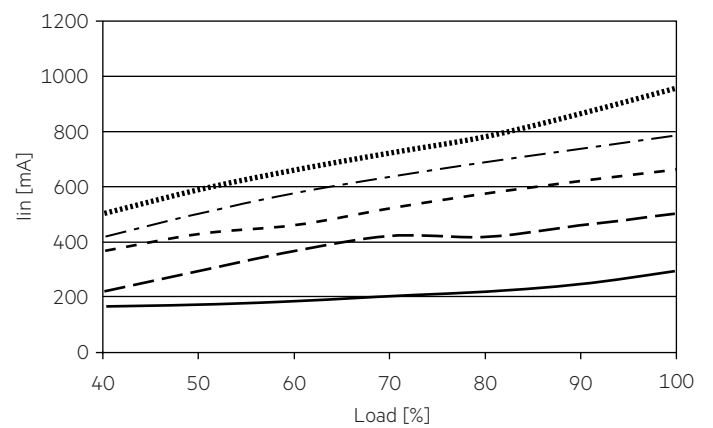

4.4.3 Input current vs. load 277 V, 60 Hz

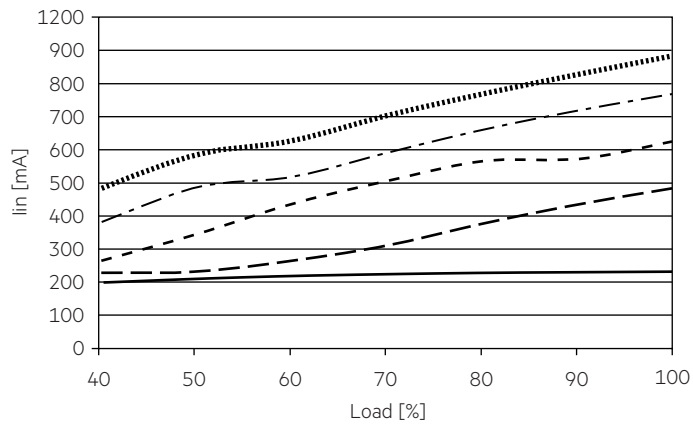

4.5.3 Input power vs. load 277 V, 60 Hz

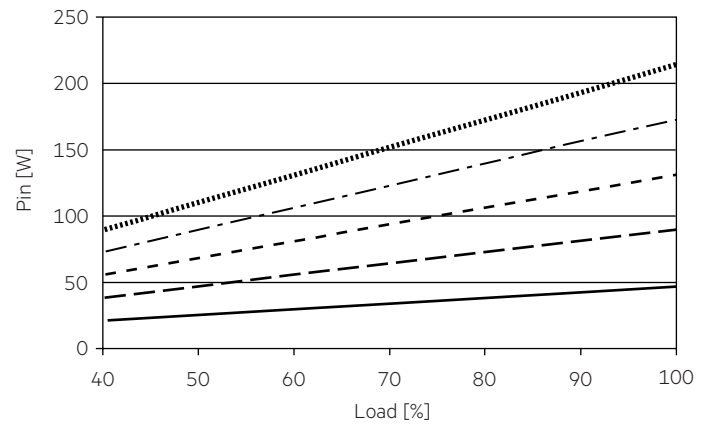

4.5.1 Input power vs. load 120 V, 60 Hz

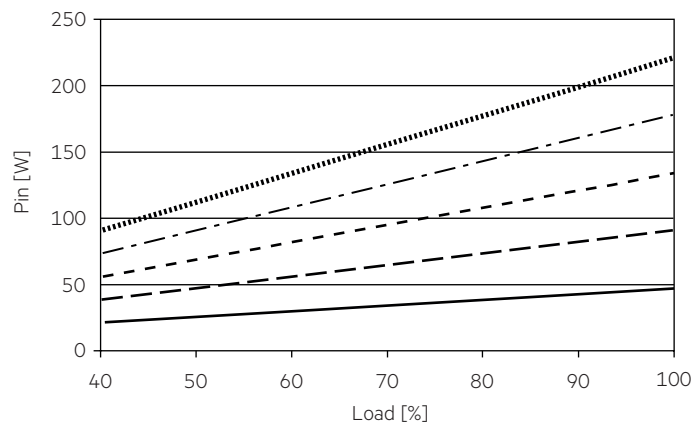

- 40 W
- - - 80 W
- · - · 120 W
- - - - 160 W
- 200 W

4.5.2 Input power vs. load 230 V, 50 Hz

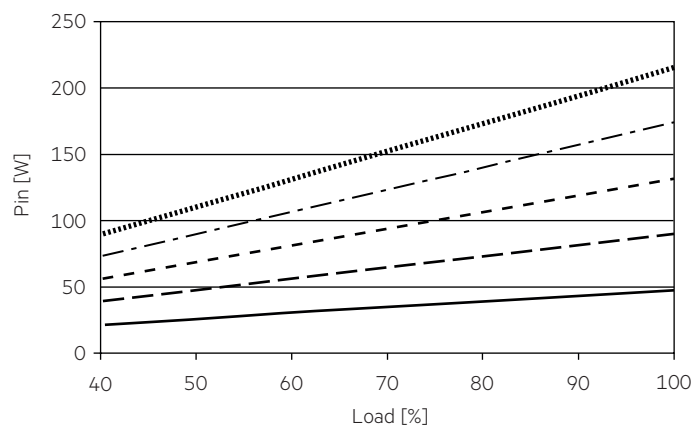

4.6 Maximum loading of automatic circuit breakers

Maximum loading of automatic circuit breakers at 120 V, 60 Hz

Automatic circuit breaker type	C10	C13	C16	C20	B10	B13	B16	B20	Inrush current	
Installation Ø	1.5 mm ²	1.5 mm ²	2.5 mm ²	2.5 mm ²	1.5 mm ²	1.5 mm ²	2.5 mm ²	2.5 mm ²	I _{max}	time
LC 200W 24V IP67 L EXC UNV	2	2	3	4	1	2	2	3	37.8 A	740 µs

Maximum loading of automatic circuit breakers at 230 V, 50 Hz

Automatic circuit breaker type	C10	C13	C16	C20	B10	B13	B16	B20	Inrush current	
Installation Ø	1.5 mm ²	1.5 mm ²	2.5 mm ²	2.5 mm ²	1.5 mm ²	1.5 mm ²	2.5 mm ²	2.5 mm ²	I _{max}	time
LC 200W 24V IP67 L EXC UNV	2	2	3	4	1	2	2	3	49.4 A	1.096 µs

Maximum loading of automatic circuit breakers at 277 V, 60 Hz

Automatic circuit breaker type	C10	C13	C16	C20	B10	B13	B16	B20	Inrush current	
Installation Ø	1.5 mm ²	1.5 mm ²	2.5 mm ²	2.5 mm ²	1.5 mm ²	1.5 mm ²	2.5 mm ²	2.5 mm ²	I _{max}	time
LC 200W 24V IP67 L EXC UNV	2	2	3	4	1	2	2	3	52 A	1.236 µs

4.7 Harmonic distortion in mains supply in %

120 V, 60 Hz:

Type	THD	3	5	7	9	11
LC 200W 24V IP67 L EXC UNV	< 15	< 12	< 10	< 7	< 5	< 3

230 V, 50 Hz:

Type	THD	3	5	7	9	11
LC 200W 24V IP67 L EXC UNV	< 15	< 12	< 10	< 7	< 5	< 3

277 V, 60 Hz:

Type	THD	3	5	7	9	11
LC 200W 24V IP67 L EXC UNV	< 15	< 12	< 10	< 7	< 5	< 3

Acc. to 6100-3-2. Harmonics < 5 mA or < 0.6 % (whatever is greater) of the input current are not considered for calculation of THD.

5. Functions

5.1 Short-circuit behaviour

In case of a short circuit on the secondary side (LED) the LED driver switches off. After elimination of the short-circuit fault the LED driver will recover automatically.

5.2 No-load operation

The LED driver will not be damaged in the no-load operation. A voltage of 25.2V DC is permanent at the output.

5.3 Over load protection

If the maximum load is exceeded by a defined internal limit, the LED driver enter hiccup modus. After elimination of the overload fault the LED driver will recover automatically.

5.4 Over temperature protection

Over temperature protection will be activated for $t_c > 90^\circ\text{C}$. The Driver is shot down when over temperature protection triggered. Auto-recovery when fault condition removed.

6. Miscellaneous

6.1 Insulation and electric strength testing of luminaires

Electronic devices can be damaged by high voltage. This has to be considered during the routine testing of the luminaires in production.

According to UL 8750 (informative only!) each luminaire should be submitted to an insulation test with 500 V_{DC}. The dielectric withstand test equipment shall employ a transformer of 500-VA or larger capacity and have a variable output voltage that is essentially sinusoidal or continuous direct current. The applied potential is to be increased from zero at a substantially uniform rate until the required test level is reached, and is to be held at that level for 1 minute.

As an alternative, UL8750 (informative only!) describes a test of the electrical strength with 2V AC + 1000V (or 1.414 x V DC). To avoid damage to the electronic devices this test must not be conducted.

6.2 Conditions of use and storage

Humidity: 10 % up to max. 95 %, not condensed (max. 56 days/year at 95 %)

Storage temperature: -40 °C up to max. +85 °C

The devices have to be within the specified temperature range (ta) before they can be operated.

The LED driver is declared as inbuilt LED controlgear, meaning it is intended to be used within a luminaire enclosure.

If the product is used outside a luminaire, the installation must provide suitable protection for people and environment (e.g. in illuminated ceilings).

6.3 Additional information

Additional technical information at www.tridonic.com → Technical Data

Lifetime declarations are informative and represent no warranty claim. No warranty if device was opened.