

Driver LCO 12W 250/350/500mA 0-10V C ADV UNV

OUTDOOR advanced series (US applications)



Product description

- _ Constant current LED driver
- _ Only for US applications
- _ Dimmable via 0 ... 10 V interface
- _ Dimming range 10 to 100 %
- _ Class 2 power supply
- _ FCC Part 15
- _ Dry and damp location
- _ Max. output power 12 W
- _ Up to 81.5 % efficiency
- _ 5 years guarantee (conditions at <https://www.tridonic.com/manufacture-guarantee-conditions>)

Housing properties

- _ Casing: polycarbonate, black
- _ Potted style
- _ Type of protection IP66

Functions

- _ Over voltage protection
- _ Short-circuit protection
- _ No-load protection

Typical applications

- _ For track lighting, small LED modules, light commercial, sconce, lantern

Website

<http://www.tridonic.com/>



Driver LCO 12W 250/350/500mA 0-10V C ADV UNV

OUTDOOR advanced series (US applications)

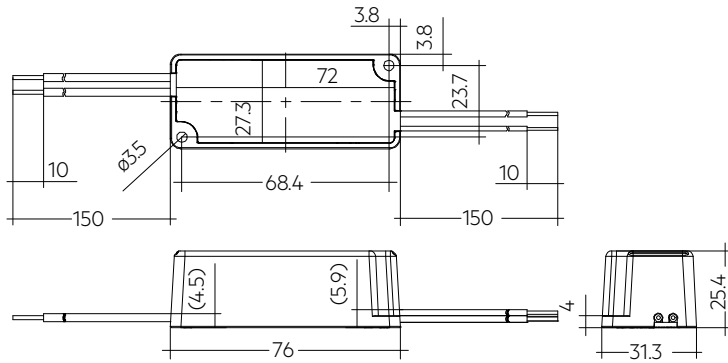

Dimensions in mm

Approval marks**Standards**

UL 8750, UL 1310, FCC PART 15, ANSI C62.41, ANSI C63.4, UL 1012, NEMA 4, CSA C22.2

1. Standards

UL 8750
 UL 1310
 FCC Part 15, Class B
 ANSI C62.41
 ANSI C63.4
 UL 1012
 NEMA 4
 CSA C22.2

Product not designed for European Economic Area.

This device complies with Part 15 of the FCC Rules. Operation is subject to the following two conditions:

- (1) this device may not cause harmful interference, and
- (2) this device must accept any interference received, including interference that may cause undesired operation.

2. Thermal details and life-time

2.1 Expected life-time

Expected life-time 120 V

Type	ta	55 °C / 131 °F	60 °C / 140 °F
LCO 12/250/48 0-10V C ADV UNV	tc	85 °C / 185 °F	90 °C / 194 °F
	Life-time	>100,000 h	90,000 h
LCO 12/350/36 0-10V C ADV UNV	tc	80 °C / 176 °F	85 °C / 185 °F
	Life-time	85,000 h	60,000 h
LCO 12/500/24 0-10V C ADV UNV	tc	80 °C / 176 °F	85 °C / 185 °F
	Life-time	95,000 h	75,000 h

Expected life-time 277 V

Type	ta	55 °C / 131 °F	60 °C / 140 °F
LCO 12/250/48 0-10V C ADV UNV	tc	90 °C / 194 °F	95 °C / 203 °F
	Life-time	>100,000 h	85,000 h
LCO 12/350/36 0-10V C ADV UNV	tc	80 °C / 176 °F	85 °C / 185 °F
	Life-time	85,000 h	60,000 h
LCO 12/500/24 0-10V C ADV UNV	tc	80 °C / 176 °F	85 °C / 185 °F
	Life-time	90,000 h	70,000 h

The LED Driver is designed for a life-time stated above under reference conditions and with a failure probability of less than 10 %.

3. Installation / wiring

3.1 Circuit diagram

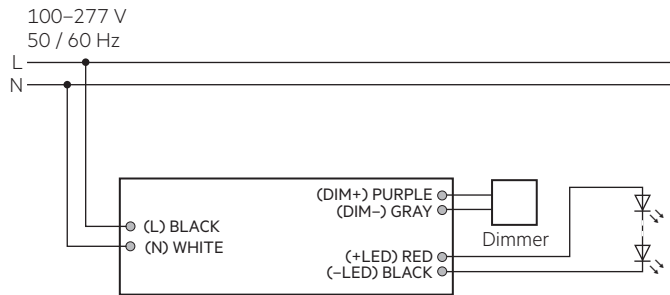

Primary cable		Secondary cable		Dimmer cable	
N	L	-	+	-	+
white	black	black	red	gray	purple

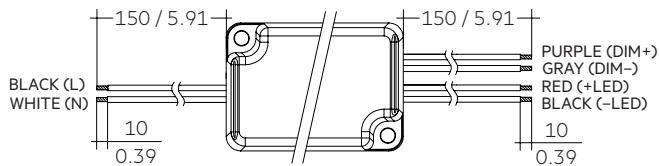

3.2 Wiring type and cross section

The max. wiring specification section for the AC input wire.
Recommended max. wiring distance at full load:

AWG	#20	#19	#18	#17	#16
Distance (m)	14	18	22	28	36
Distance (ft)	45.9	59	72.2	91.9	118.1

For the output wire diameter should be a minimum of 20AWG.
The max. cable length should use for the dimming wire:

- 300 inch (7.62 m) for a cable size 18AWG
- 400 inch (10.16 m) for a cable size 16AWG

3.3 Wiring guidelines

- All connections must be kept as short as possible to ensure good EMI behaviour.
- Mains leads should be kept apart from LED Driver and other leads (ideally 5 – 10 cm / 1.97 – 3.94 inch distance)
- Max. length of output wires is 2 m / 6.56 feet.
- Secondary switching is not permitted.
- Incorrect wiring can damage LED modules.
- To avoid the damage of the Driver, the wiring must be protected against short circuits to earth (sharp edged metal parts, metal cable clips, louver, etc.).

3.4 Hot plug-in

Hot plug-in or secondary switching of LED's is not permitted and may cause a very high LED output current.

3.5 Replace LED module

1. Mains off
2. Remove LED module
3. Wait for 20 seconds
4. Connect LED module again

4. Electrical values

4.1 Efficiency vs load

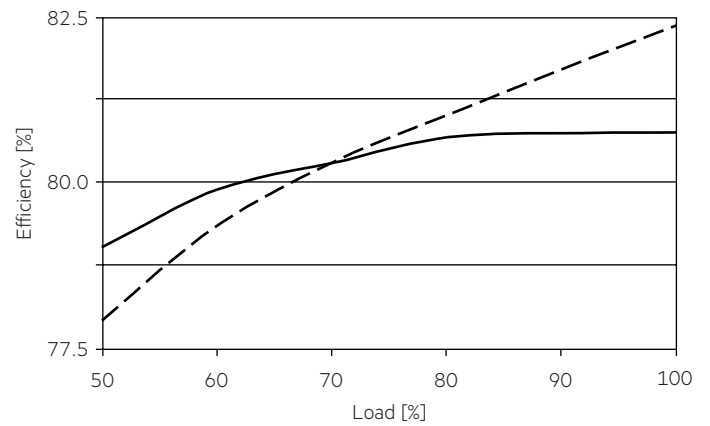

4.3 Power factor vs load

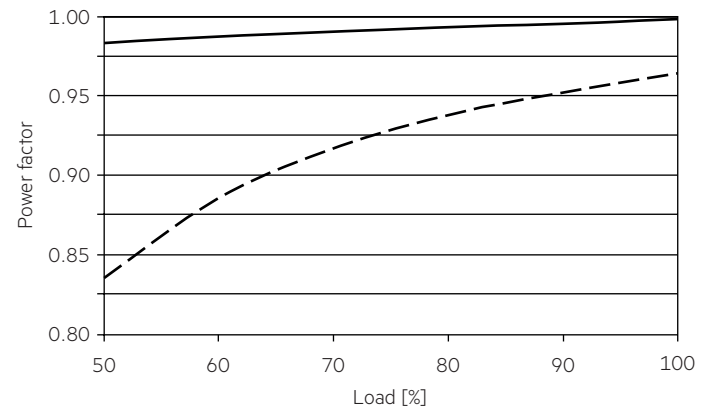

4.4 THD vs load

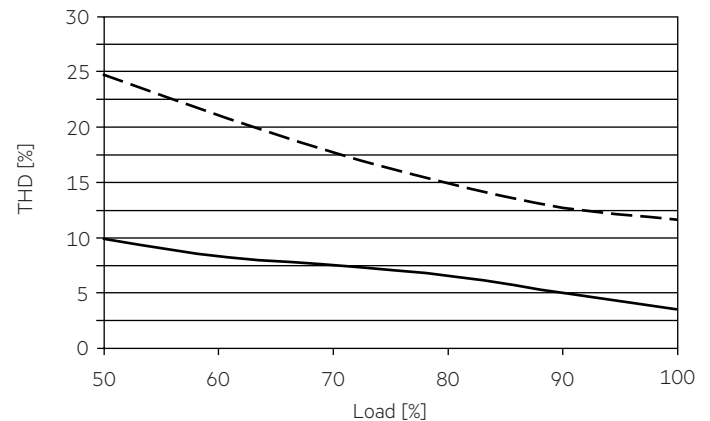

— 120 V, 500 mA
- - - 277 V, 500 mA

4.5 Harmonic distortion in the mains supply in %

120 V, 60 Hz:

	THD	3.	5.	7.	9.	11.
LCO 12/250/48 0-10V C ADV UNV	< 5	< 5	< 2	< 2	< 2	< 1
LCO 12/350/36 0-10V C ADV UNV	< 6	< 3	< 1	< 1	< 1	< 1
LCO 12/500/24 0-10V C ADV UNV	< 5	< 3	< 1	< 1	< 1	< 1

277 V, 60 Hz:

	THD	3.	5.	7.	9.	11.
LCO 12/250/48 0-10V C ADV UNV	< 8	< 8	< 3	< 3	< 2	< 1
LCO 12/350/36 0-10V C ADV UNV	< 10	< 7	< 5	< 2	< 2	< 2
LCO 12/500/24 0-10V C ADV UNV	< 10	< 7	< 4	< 2	< 1	< 1

Acc. to 61000-3-2. Harmonics < 5 mA or < 0.6 % (whatever is greater) of the input current are not considered for calculation of THD.

4.6 Dimming

Dimming range is 10 to 100%.

4.7 Dimming curve is linearised

Control input (0 – 10 V)

Control input open	max. dimming level
Control input short-circuited	min. dimming level
Max. output source current	1.2 mA
Max. permitted input voltage	-2 ... +15 V
Voltage range dimming	0 – 10 V ^①
Input voltage < 1 V	min. dimming level ^①
Input voltage > 10 V	max. dimming level ^①

^① See graph below (at full load):

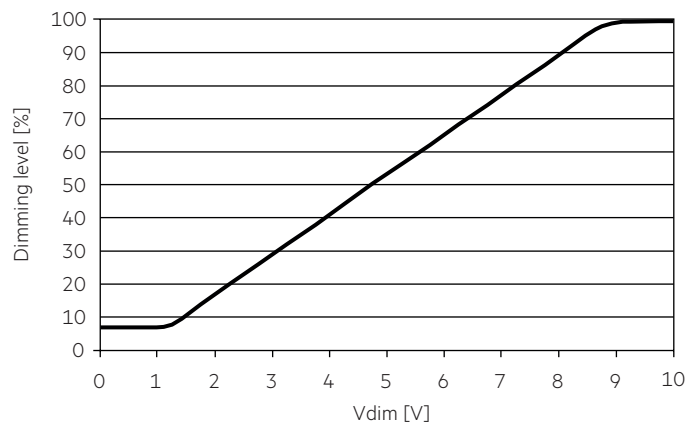

5. Functions

5.1 Short-circuit behaviour

The Driver will go to hic-cup mode when the output is short, after elimination of the short circuit fault the LED Driver will recover automatically.

5.2 No-load operation

LED Driver works in standby mode when the output is open, the Driver will not damage and the output voltage will have the constant voltage.

5.3 Overload protection

If the output voltage range is exceeded, LED Driver will work in hic-cup working mode, after elimination of the overload the nominal operation will recover automatically.

6. Miscellaneous

6.1 Insulation and electric strength testing of luminaires

Electronic devices can be damaged by high voltage. This has to be considered during the routine testing of the luminaires in production.

According to UL 8750 (informative only!) each luminaire should be submitted to an insulation test with 500 V_{DC}. The dielectric withstand test equipment shall employ a transformer of 500-VA or larger capacity and have a variable output voltage that is essentially sinusoidal or continuous direct current. The applied potential is to be increased from zero at a substantially uniform rate until the required test level is reached, and is to be held at that level for 1 minute.

As an alternative, UL8750 (informative only!) describes a test of the electrical strength with 2V AC + 1000V (or 1.414 x V DC). To avoid damage to the electronic devices this test must not be conducted.

6.2 Conditions of use and storage

Humidity: 5% up to max. 95%,
not condensed
(max. 56 days/year at 95%)

Storage temperature: -40 °C / -40 °F up to max. +80 °C / +176 °F

The devices have to be acclimatised to the specified temperature range (ta) before they can be operated.

6.3 Additional information

Additional technical information at www.tridonic.com → Technical Data

Guarantee conditions at www.tridonic.com → Services

Life-time declarations are informative and represent no warranty claim.
No warranty if device was opened.