

CC COMPACT
DIP SWITCH
DIMMABLE FLAT



PrimeLine DIP switch C-R3 flat DALI2

187053, 187054

Typical Applications

Built-in in compact luminaires

- Shop lighting
- Downlights



PrimeLine DIP switch C-R3 flat DALI2

- **FLAT LAYOUT < 22 MM**
- **VERY LOW RIPPLE CURRENT: < 3%**
- **DIMMABLE: DALI (ED. 2)**
- **SUITABLE FOR BUILT-IN INTO FURNITURE**
- **SUITABLE FOR EMERGENCY ESCAPE LIGHTING SYSTEMS ACC. TO EN 50172**
- **WITH INTEGRATED CORD GRIP FOR INDEPENDENT OPERATION**
- **SELV**
- **SELECTABLE OUTPUT CURRENT VIA DIP SWITCH**
- **LONG SERVICE LIFE: UP TO 100,000 HRS.**
- **PRODUCT GUARANTEE: 5 YEARS**



PrimeLine DIP switch C-R3 Flat

Product features

- Compact casing shape
- For independent operation with cord grip
- For built-in without cord grip

Functions

- The required current output can be chosen by dip switches.
- Suitable for central battery system for emergency lighting acc. to EN 50172

Electrical features

- Mains voltage: 220–240 V $\pm 10\%$
- Mains frequency: 50–60 Hz
- DC operation: 198–276 V, 0 Hz
- Push-in terminals: 0.5–1.5 mm²
- Power factor at 12 W: 0.95
- Standby losses: < 0.5 W
- Open circuit voltage (U_{max.}): 60 V
- Secondary side switching of LED modules is not allowed.

Dimming

- Dimming range: 1 to 100%
- If no dimming interface is connected, brightness will stay at 100%.

Safety features

- Protection against transient main peaks up to 2 kV (between L and N) and up to 4 kV (between L/N and PE)
- Electronic short-circuit protection
- Overload protection
- Overtemperature protection
- Protection against "no load" operation
- Degree of protection: IP20
- Protection class I (built-in version); protection class II (independent version)
- SELV
- SVM: < 0.4
- PstLM: < 1

Packaging units

Ref. No.	Packaging unit		Weight g
	Pieces per box	Boxes per pallet	
Built-in drivers			
187053	50	80	94
Independent drivers			
187054	50	80	113

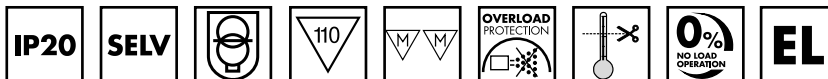

Dimensions built-in drivers

- Casing: K33.5 (187053)
- Length: 97.5 mm
- Width: 42.5 mm
- Height: 22.0 mm

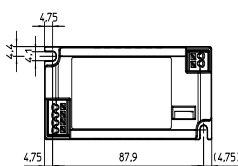
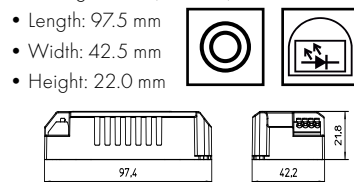

Dimensions independent drivers

- Casing: K33.5 (187054)
- Length: 146.5 mm
- Width: 43.5 mm
- Height: 22.0 mm

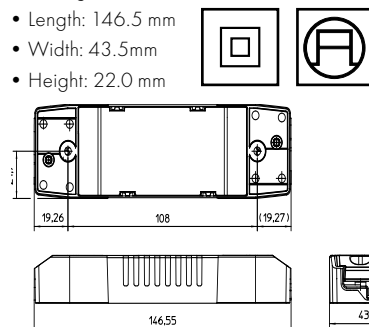

Applied standards

- EN 61347-1
- EN 61347-2-13
- EN 61547
- EN 61000-3-3
- EN 62384
- EN 55015
- IEC 62386 ed. 2 part 102/103/207
- VDE 0710-T14



Dimming

Analogue



Product guarantee

- 5 years
- The conditions for the Product Guarantee of the Vossloh-Schwabe Group shall apply as published on our homepage (www.vossloh-schwabe.com). We will be happy to send you these conditions upon request.

The values contained in this data sheet can change due to technical innovations. Any such changes will be made without separate notification.

LED Drivers – Primeline DIP switch C-R3 Flat

Electrical characteristics

Max. output W	Type	Ref. No.		Voltage 50–60 Hz V	Mains current mA	Inrush current A / μ s	Current output DC mA	Voltage output DC (V)	THD %	Efficiency at full load % (230 V)	Ripple 100 Hz %
		built-in	independent								
11.5	ECXd 700.436	187053	187054	220–240	200	5 / 50	250 \pm 6%	10–49	< 10	> 89	< 3
13.0							280 \pm 6%	10–49			
14.5							310 \pm 6%	10–49			
15.5							340 \pm 6%	10–48			
16.7							370 \pm 5%	10–48			
18.0							400 \pm 5%	10–47			
19.2							430 \pm 5%	10–47			
20.5							460 \pm 5%	10–47			
21.5							490 \pm 5%	10–46			
22.8							520 \pm 5%	10–46			
23.7							550 \pm 5%	10–45			
24.5							580 \pm 5%	10–44			
25.7							610 \pm 5%	10–44			
26.0							640 \pm 5%	10–41			
26.0							670 \pm 5%	10–39			
26.0							700 \pm 5%	10–37			

Maximum ratings

Exceeding the maximum ratings can lead to reduction of service life or destruction of the drivers.

Ref. No.	Ambient temperature range		Operation humidity range		Storage temperature range		Storage humidity range		Max. operation temperature at t_c point °C	Degree of protection
	°C min.	°C max.	% min.	% max.	°C min.	°C max.	% min.	% max.		
187053	-25	+45	5	80	-30	+80	5	85	+80	IP20
187054	-25	+40								

Expected service life time

at operation temperatures at t_c point

Operation current	Ref. No.	
	All	
Max.	70 °C	80 °C
hrs.	100,000	50,000

Product labels and dip-switch settings

DIP SWITCH SETTINGS		ImaxmA	Pout(W)
-	-	250	11.5
-	-	280	13
-	-	310	14.5
-	-	340	15.5
-	-	370	16.7
-	-	400	18
-	-	430	19.2
-	-	460	20.5
-	-	490	21.5
-	-	520	22.8
-	-	550	23.7
-	-	580	24.5
-	-	610	25.75
-	-	640	26
-	-	670	26
-	-	700	26

The values contained in this data sheet can change due to technical innovations. Any such changes will be made without separate notification.

Typ. performance graphs for 187053, 187054 / Type ECXd 700.436

Working area

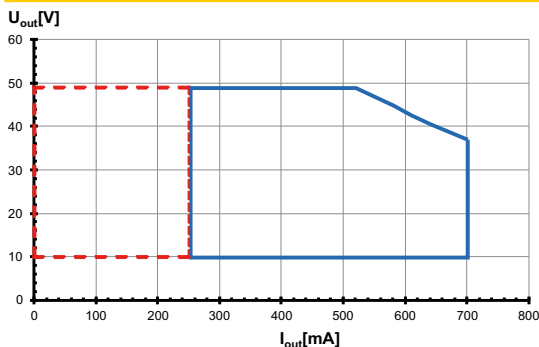

Efficiency

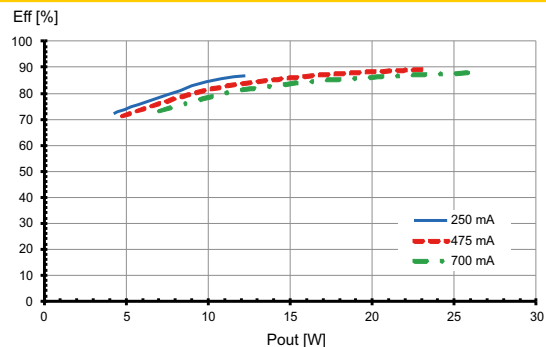

Power factor

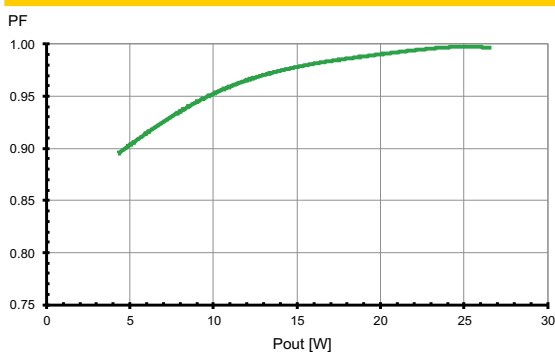

Total harmonic factor (THD)

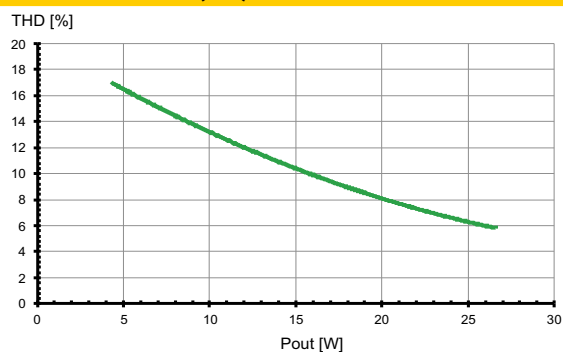

Safety functions

- Transient mains peaks protection:
 - Values are in compliance with EN 61547 (interference immunity).
 - Surges between L–N: up to 2 kV and up to 4 kV between L/N and PE
- Short-circuit protection:
 - The control gear is protected against permanent short-circuit with automatic restart function.
- Overload protection:
 - The control gears have overload protection due to limitation of DC output voltage < 60 V.
 - Please check before switch-on mains power supply that the selected LED load is suitable (see Electrical Characteristics on data sheet).
- Overheating:
 - The control gears have overheating protection.
 - In case of overheating the control gear will shut down. For restart switch of the mains for 1 min. and start again.
 - The temperature reduces the output current of the control gear in the event of overheating.
- No load operation:
 - The control gear is protected against no load operation (open load).
- If any of the above mentioned safety functions will be triggered, disconnect the control gear from the power supply then find and eliminate the cause of the problem.

DC and emergency lighting operation

The control gears are suitable for direct voltage operation (DC). Reliable DC operation is guaranteed if the specified working area of LED driver is maintained.

- Light level at DC operation (EOFx):
 - 100 % (not adjustable)
- DC range: 198–276 V
- DC operation: 3 hrs. (acc. to EN 50172)

Corridor function

To enable a predefined corridor function profile please follow the instructions below:

- Enable: press the push button for ($t > 60$ s) to activate the corridor function.
- Disable: disconnect the driver from mains for ($t > 5$ s) to deactivate the corridor function.
- 100 % light: Keep the button pressed.
- The fade off time is 30 seconds, light intensity 10%.
- The prolong time is 30 minutes, then off.

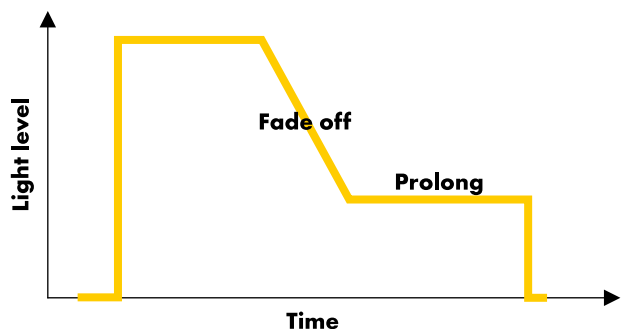

The values contained in this data sheet can change due to technical innovations. Any such changes will be made without separate notification.

Assembly and Safety Information

Installation must be carried out under observation of the relevant regulations and standards. Installation must be carried out in a voltage-free state (i.e. disconnection from the mains). The following advices must be observed; non-observance can result in the destruction of the LED drivers, fire and/or other hazards.

Mandatory regulations

- DIN VDE 0100
- EN 60598-1

Mechanical mounting

- Mounting position: Built-in: Any position inside a luminaire is allowed
Independent application: Drivers with integrated cord grip are allowed to use for independent applications.
- Mounting location: LED drivers are designed for integration into luminaires or comparable devices.
Independent LED drivers do not need to be integrated into a casing.
Installation in outdoor luminaires: degree of protection for luminaire with water protection rate ≥ 4 (e.g. IP54 required).
- Degree of protection: IP20
- Clearance: Min. 0.10 m from walls, ceilings and insulation
- Surface: Solid and plane surface for optimum heat dissipation required.
- Heat transfer: If the driver is destined for installation in a luminaire, sufficient heat transfer must be ensured between the driver and the luminaire casing.
LED drivers should be mounted with the greatest possible clearance to heat sources.
During operation, the temperature measure at the driver's t_c point must not exceed the specified maximum value.
- Fastening: Using M4 screws in the designated holes
- Tightening torque: 0.2 Nm

Electrical installation

- Connection terminals: Push-in terminals for rigid or flexible conductors with a section of 0.5–1.5 mm²
- Stripped length: 9–10 mm
- Wiring: The mains conductor within the luminaire must be kept short (to reduce the induction of interference).
Mains and lamp conductors must be kept separate and if possible should not be laid in parallel to one another.
Max. secondary side lead length for independent drivers: 1 m

- Polarity: Please ensure the correct polarity of the leads prior to commissioning. Reversed polarity can destroy the modules.
- Parallel connection: At secondary side is not allowed.
- Through-wiring: Is not allowed
- Secondary load: The sum of forward voltages of LED loads is within the tolerances which are mentioned in the Electrical Characteristics on the data sheet.

Wiring diagram:

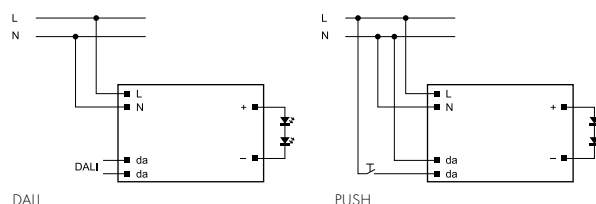

Selection of automatic cut-outs for VS LED drivers

- Dimensioning automatic cut-outs
High transient currents occur when an LED driver is switched on because the capacitors have to load. Ignition of LED modules occurs almost simultaneously. This also causes a simultaneous high demand for power. These high currents when the system is switched on put a strain on the automatic conductor cut-outs, which must be selected and dimensioned to suit.
- Release reaction
The release reaction of the automatic conductor cut-outs comply with VDE 0641, part 11, for B, C characteristics. The values shown in the following tables are for guidance purposes only and are subject to system-dependent change.
- No. of LED drivers
The maximum number of VS LED drivers applies to cases where the devices are switched on simultaneously. Specifications apply to single-pole fuses. The number of permissible drivers must be reduced by 20% for multi-pole fuses. The considered circuit impedance equals 400 m Ω (approx. 20 m [2.5 mm²] of conductor from the power supply to the distributor and a further 15 m to the luminaire).

Type	Ref. No.	Automatic cut-out type and possible no. of VS drivers pcs.			
Automatic cut-out type B		B 10 A	B 13 A	B 16 A	B 20 A
ECXd 700.436	187053, 187054	66	86	106	133
Automatic cut-out type C		C 10 A	C 13 A	C 16 A	B 20 A
ECXd 700.436	187053, 187054	66	86	106	133
Automatic cut-out type K		K 10 A	K 13 A	K 16 A	B 20 A
ECXd 700.436	187053, 187054	66	86	106	133

- To limit capacitive inrush currents the current carrying capacity of each circuit breaker (fuse) can be increased by a factor of 2.5 with the help of our ESB (Ref. No.: 149820, 149821, 149822) inrush current limiters.

The values contained in this data sheet can change due to technical innovations. Any such changes will be made without separate notification.